

Eccellenza momentum™



3.1.0

Operation Manual

KEURIG®



Carefully read this instruction manual before proceeding with the installation and operation of this equipment. Keep this manual in a safe place for future reference.

Disclaimer:

Although the utmost care was taken putting together this publication, Keurig® accepts no liability for inaccuracies or omissions to this publication. Keurig® is not responsible for misinterpretation of any information contained in this publication. Keurig® is not responsible for injuries or damages resulting from incorrect or improper use of this equipment, unauthorized modifications to the equipment, the use of non-original replacement components in the equipment, or improper installation of the equipment.

Copyright:

© 2022 Keurig®

The information and contents of this publication are property of Keurig®. No part of this publication can be reproduced, reused, modified or published in any format without the written permission of Keurig®.

Keurig® reserves the right to change the specifications to the equipment, and to modify the information contained in this publication at any time and without prior notification to the purchaser of this equipment. All rights are reserved.

To view and download other equipment documentation, visit the "Customer" section of our web site at the following URL: <http://www.vkitech.com>

Contact Information:	Contactez-nous:
<p>U.S.A.</p> <p>Phone Customer Service: 1.888.287.2739 option 1 Technical Support: 1.888.287.2739 option 5</p> <p>Email: Customer Service: orders@gmcr.com Technical Support: FIELD_SERVICE_TEAM-Keurig@kdrp.com</p>	<p>États Unis</p> <p>Téléphone Service à la clientèle: 1.888.287.2739 option 1 Service technique: 1.888.287.2739 option 5</p> <p>Courriel Service à la clientèle: orders@gmcr.com Service technique: FIELD_SERVICE_TEAM-Keurig@kdrp.com</p>
<p>Canada</p> <p>Phone Customer Service: 1.888.382.1145 Technical Support: 1.888.854.0207</p> <p>Email: Customer Service: ca.b2b@gmcr.com Technical Support: tech.support@kdrp.com</p>	<p>Canada</p> <p>Téléphone Service à la clientèle: 1.888.382.1145 Service technique: 1.888.854.0207</p> <p>Courriel Service à la clientèle: ca.b2b@gmcr.com Service technique: tech.support@vkitech.com</p>

Table of Contents

Section 1 - Safety Information & Equipment Specifications	7
<i>Safety Symbols</i>	7
<i>Important Safeguards and Precautions</i>	8
<i>Specifications</i>	10
<i>Capacities</i>	10
<i>Equipment Dimensions</i>	10
<i>Installation Dimensions</i>	10
Section 2 -	11
Setting up the Equipment	11
<i>Unpacking</i>	11
<i>Unlocking the Front Door and the Waste Bin</i>	13
<i>Cup Detection</i>	13
<i>Equipment Overview – Exterior</i>	14
<i>Equipment Overview - Interior</i>	14
<i>Installation Precautions</i>	15
<i>Water Connection</i>	15
<i>Water Filter</i>	16
<i>Starting the Equipment</i>	16
Service Power Switch	16
<i>The Touch Screen</i>	17
Selecting and Dispensing a Beverage Using the Touchscreen	17
Selecting and Dispensing a Beverage Using Keurig® Remote Brew App (optional Touchless Kit required)	18
<i>Filling the Coffee Bean Dispensers</i>	19
<i>Filling the Powder Dispensers</i>	20
<i>Setting the Cup Stand Overflow Detection</i>	21
<i>Installing a Cup Stand Drain</i>	21
<i>Checking Water Temperature</i>	22
<i>Initial Adjustments</i>	22
Change PINs for the Operator and Administrator	22
Setting the Date and Time	22
Water Levels	22
Gram Throws	22
Beverages	22
Notifications	22
<i>Clearing Error and Reminder Messages</i>	23
<i>System Status Report Screen</i>	24
Section 3 - Configuring the Equipment	26
<i>Accessing the Configuration System</i>	26
<i>Programming Menu Structure</i>	28
Menu Drop-List Overview	28
Sub-Menu Tabs	29
Exiting the Setup	29
<i>Dashboard</i>	30
Counters	30
Beverages Tab	32
Ingredients Tab	35

Emailing Data or Saving it to a USB Flash Drive	35
<i>System Status</i>	36
Current Status	36
Fault Codes.....	37
Logs	38
System Info	38
Event Deactivation	39
<i>General Settings</i>	41
Installation	41
Waste Management (Waste Chute)	41
Cup Detection	41
Regional	41
Language	41
Units of Measure.....	42
Date and Time	43
Auto Rinsing.....	44
Counter Trigger	44
Periodic Trigger	45
<i>Power Settings</i>	46
Screensaver.....	46
Energy Saving.....	47
<i>Vending (Cashless Pay)</i>	51
General Tab.....	51
Beverages Tab.....	52
Setting the Base Price	53
Adjusting the Price for Exceptions	55
Pricing Hot Water.....	56
Devices Tab	56
<i>Network</i>	57
WIFI	57
Hidden SSID.....	59
SMTP	60
Online SMTP Server Providers	61
Notifications.....	61
Telemetry.....	64
<i>Setup</i>	65
Hoppers.....	65
Beverages.....	65
Setting Cup Strength	65
Setting the Default Coffee Blend	66
Disabling Beverages	67
Configuring Cup Sizes.....	68
Setting the Default Cup Size.....	68
Selecting and Customizing Cup Size Labels.....	69
Configuring the Carafe	74
Ingredients	75
Recipes	78
Setting Coffees	78
Gourmet Mode	82
Setting Specialty Beverages	83

Disabling “Press & Hold” Hot Water	85
Restore Defaults.....	86
Water	87
Brewing	92
Water Temperature	93
Advanced (Beverage Set Selection)	94
Security.....	95
Administrator	96
Operator.....	98
Maintenance.....	100
Cleaning & Sanitizing Tab.....	100
Standard Rinsing Section.....	100
Brewer Rinse	100
Mixers Rinse	100
Cleaning & Sanitizing Section.....	101
Brewer Cleaning	101
Grinder Cleaning	102
Operations Tab.....	103
Wiper Home Position	103
Remove Filter	103
Calibrate Powder Level	103
Calibration.....	104
Calibrate Coffee Gram Throw	104
Calibrate Powder Low Level Detection	105
Manual Activation.....	106
Coffee System	106
Powder System	108
Water System.....	109
Miscellaneous Components.....	109
Multimedia.....	111
System Default	111
Follow Beverage Set.....	111
User.....	111
Copy from Media Set	113
Requesting Custom Images or Videos	114
Multimedia Specifications.....	114
Section 4 - Care and Maintenance.....	115
Daily Care.....	115
Every 1-2 Weeks.....	115
Every 15,000 Cycles or 12 Months	115
Every 3 Years.....	116
Miscellaneous	116
Section 5 - Error and Reminder Messages	117
Main Screen	117
System Status Screen	118
Section 6 - Updating Firmware.....	125
Section 7 - Installing the Card Reader Option	127
Section 8 - Product Warranty Information.....	134

SECTION 1

Safety Information & Equipment Specifications

Your safety is extremely important to us. To avoid personal injury or damage to the equipment and its surrounding areas, it is **imperative** that you read and understand the safety information outlined in this section before proceeding with the installation and operation of this equipment.

Safety Symbols

The following symbols are used throughout this publication:



Indicates an electrical shock hazard.



Indicates a potential safety risk, or a risk of damage to equipment and/or its surroundings.



Indicates important information that must be understood before proceeding.



Indicates an important note or useful tip.

Important Safeguards and Precautions

- This equipment is designed for indoor use **ONLY** and must **never** be installed outdoors.
- This equipment requires a 120-Volt 20-Amp wall outlet like the one shown below:

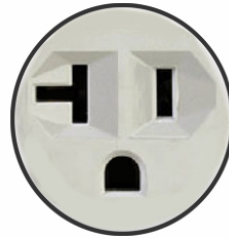





- The installation of this equipment **must** comply with **all** municipal, state/provincial, and federal electrical and plumbing codes.
- Installation and servicing of this equipment must **only be performed by qualified personnel**. Do not attempt to install or service this equipment if you are not qualified as it may result in personal injury. There are no user-serviceable parts inside the equipment.
- Do not use an electrical extension cord or power bar.
- This equipment must be installed in a location with an ambient temperature between 5°C - 35°C (40°F - 95°F).
- The main water supply pressure must be between a minimum of 20psi and a maximum of 100psi.
- The temperature of the main water supply entering the machine must not exceed 49°C (120°F)
- This equipment must be positioned so that the wall plug and the main power switch are both easily accessible.
- Do not connect this equipment to a voltage supply other than the voltage indicated on the serial number decal.
- Do not immerse this equipment, or any part of this equipment, in liquid.
- Do not install the equipment in an area where water spray is present.
- This equipment must be installed securely on a level surface. If it does not appear to be a stable location, select another installation location.
- Leave a **minimum of 2" (5cm)** of space all around this equipment for proper ventilation.
- Keep hands clear of the dispensing area at the front of this equipment. Liquids being dispensed are extremely hot and can cause severe burns.

- **Never** disconnect this equipment from the wall outlet by pulling on the service cord, and never use this equipment if the service cord is damaged.
- If the service cord is damaged, **it must be replaced with a new service cord** that is available from your distributor or the manufacturer of this equipment.
- **Never** circumvent the safety features incorporated into the equipment. They are there for your protection and **should never be disabled or bypassed under any circumstances**.
- **Always** switch the power off and disconnect the service cord when cleaning the interior of this equipment. Components inside this equipment can cause electrical shock resulting in personal injury.
- Use caution when servicing the water tank or any of its components - the water in the tank and the tank components may be extremely hot and can cause severe burns.
- Use caution when working inside this equipment as there may be sharp edges on some components that can cause cuts.
- To prevent electrical shock, remove all jewelry (rings, watches, etc.) when servicing this equipment.
- **Use only original equipment manufacturer replacement parts.** Unapproved replacement parts can result in personal injury, fire and/or further damage to the equipment.
- **Do not** allow children to access this equipment. They are not aware of the potential dangers that exist.
- The **Urnex TABZ Z61, Urnex SuperGrindz A01 and Urnex RINZA** products are the **only** cleaning products approved by VKI Technologies for cleaning the brewer, the grinder and the whipper components. These products have been thoroughly tested and will not damage machine components. The use of other products may damage components and will void any remaining warranty on the damaged components.
- **Never** use ammonia-based cleaners on the surfaces of this equipment as they will become discolored and/or damaged permanently. Use mild cleaning products, such as dish soap.
- **Do not** lean on, push or shake the equipment as there is a risk that it can tip or fall, or cause water to overflow and contact electrical components creating a shock hazard.
- **Do not** operate the equipment with the rear panel removed.



Unauthorized modifications made to this equipment can result in serious personal injury and/or damage to the equipment and its surroundings (including a risk of fire), and voids all warranties and safety certifications/listings.

Specifications

Voltage Rating	120 Volts AC @ 60hz (120 Volt Model) – 20 Amp Plug
Plug/Outlet	Nema 5 – 20P 
Heater Wattage	1700 Watts
Total Wattage	1800 Watts
Weight	138 lbs (62.6 kg)
Cup Sizes	3 cup sizes (from 10-oz to 24-oz)*, plus Carafe Option (64-oz) <i>*depends on the selected "Beverage Set" (see page 86)</i>
Temperature Control	Electronic Probe
Heating Time	30 minutes after power up
Brew Temperature	198°F (92°C)
Heater Protection	Yes
Overflow Protection	Yes
Backflow Prevention	Yes
Circuit Protection	Yes
Screen Size	18.5"
Certifications & Listings	  

Capacities

Coffee Hopper 1	6 lbs (2.72 kg)	Position 1: 1 lb (0.45 kg)	Position 2: 2 lbs (0.9 kg)
Coffee Hopper 3	3 lbs (1.36 kg)	Position 1: 0.5 lb (0.22 kg)	Position 2: 1 lb (0.45 kg)
Coffee Hopper 2	6 lbs (2.72 kg)	Position 1: 1 lb (0.45 kg)	Position 2: 2 lbs (0.9 kg)
Powder Hopper 1	4 lbs (1.8 kg)		
Powder Hopper 2	4 lbs (1.8 kg)		
Powder Hopper 3	3.5 lbs (1.6 kg)		
Water Tank	2 gallons (7.6 litres)		
Waste Bin	Approximately 50 cups (12-oz)		

Equipment Dimensions

Height:	35.0" (89 cm)
Width:	20.5" (52 cm) with door closed 24.0" (61 cm) with door open
Depth:	27.0" (69 cm) with drip tray 24.5" (62 cm) without drip tray

Installation Dimensions

Height:	42.0" (107 cm)
Width:	26.0" (66 cm)
Depth:	29.0" (74 cm)



Any references made in this manual to coffee blends, powder products and beverages are for example purposes only. The actual products used in the equipment may differ from the examples used in this manual.

SECTION 2

Setting up the Equipment

Unpacking



Prior to signing for the delivery, check the shipping carton for damage. Indicate any damage on the delivery slip and have the delivery driver sign to acknowledge the damage. Damages during shipping must be claimed with the carrier, and not with VKI Technologies.

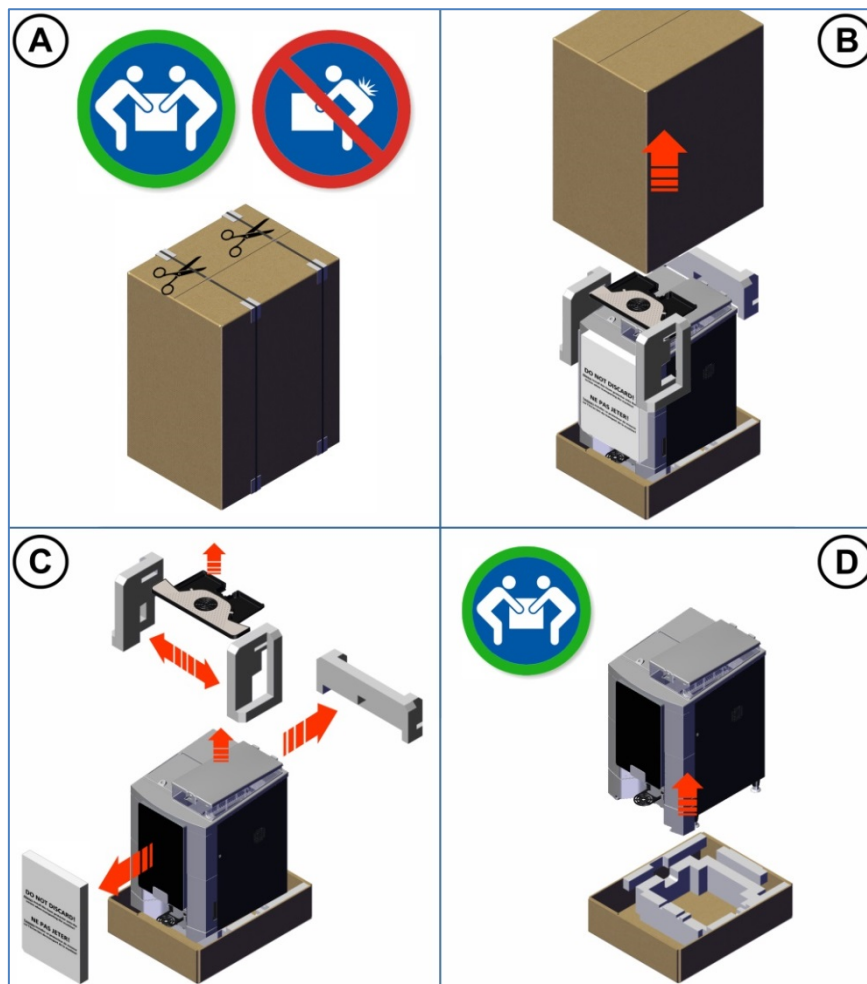

1. Cut the straps on the outside of the box (A).
2. Lift the top carton (B).
3. Remove the two side foam supports and remove the cup stand assembly secured between them (C).

- Remove the front and rear foam supports (C).

Do not discard the front foam support as it must be installed over the machine's screen to protect it during transport.



- With the **help of a colleague**, lift the coffee maker off the base of the packaging (D) and place it onto a workbench or cabinet. **Do not attempt to lift the machine by yourself.**



DO NOT lift the coffee maker by placing your hand underneath the front door. It is not designed to support the weight of the machine, and serious personal injury and/or damage to the unit may occur.

- Remove the keys and the Telemetry Antenna from the cup stand. Install the telemetry antenna to the round connector at the top right corner on the rear of the machine.

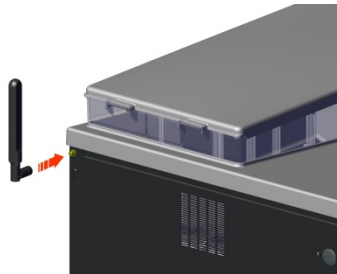

- Slide the residue chute into the slots at the bottom of the machine.

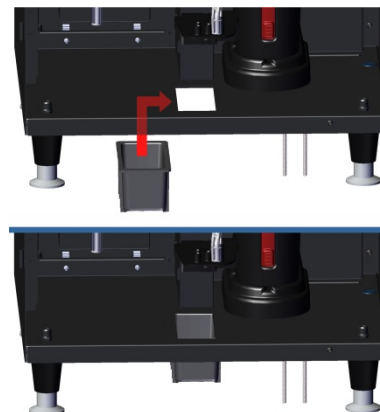

- Remove the shipping tape and protective film from the outside of the machine and from the stainless steel drip tray grill.



Keep all packaging material in case the equipment must be transported or shipped. When transporting the unit for installation, leave it on the base of the packaging to reduce the risk of damage to the levelers.

Unlocking the Front Door and the Waste Bin

The Eccellenza Momentum™ uses a multi-position lock to lock the waste bin in place and to lock the front door.



- 1** To lock both the front door and the waste bin, insert the key and turn it to **position 1**. While in this position (with everything locked), the key can be removed from the lock.
- 2** To unlock the waste bin without unlocking the front door of the machine, insert the key and turn it to **position 2**, as shown. If the key is removed while in position 2, the waste bin will remain unlocked so that anyone can empty the waste bin. If the machine is installed in a public location, we recommend removing the key in position 1, to leave the waste bin locked.
- 3** To unlock both the front door and the waste bin, insert the key and turn it to **position 3**. When the key is in this position, it **cannot** be removed from the lock.

Cup Detection

The Eccellenza Momentum™ is equipped with a cup detection system, which is activated by default. If a cup is not detected on the cup stand, it is not possible to dispense a beverage. For more information about enabling or disabling the cup detection system, go to [page 41](#).

Equipment Overview – Exterior



Equipment Overview - Interior

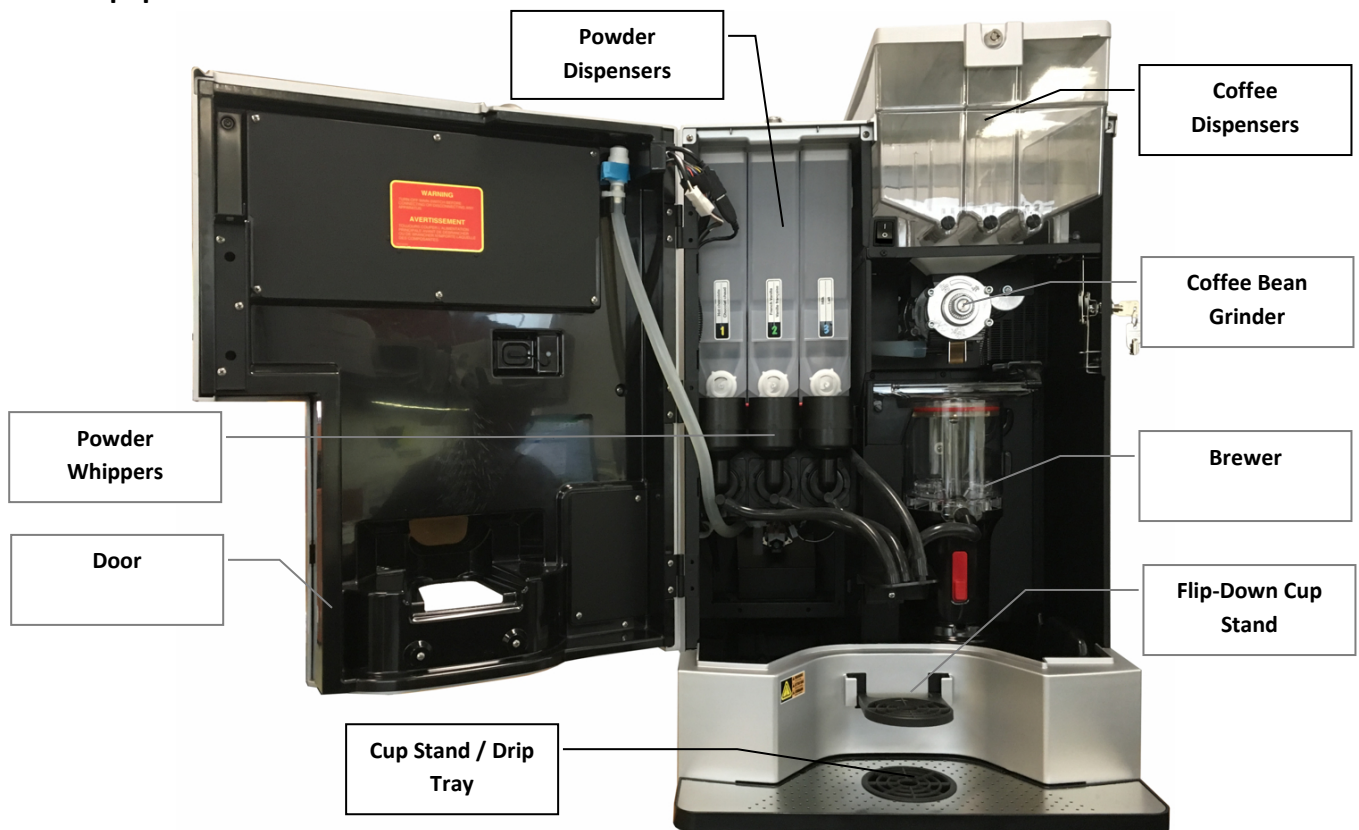

Installation Precautions



This equipment is designed for indoor use only and must never be installed outdoors.



Avoid using extension cords and power bars when connecting this equipment to a power source.



Installation of this equipment must comply with all local, state/provincial and federal codes and regulations. It is the sole responsibility of the installer to research and to comply with these codes and regulations.



This equipment must be installed on a dedicated 20 amp outlet. Do not install other equipment on the same outlet/circuit.



Ensure that the equipment is level and stable. This is done by adjusting the levelers (legs) at the bottom of the machine. Also, do not block any of the equipment's ventilation ports.



Leave room at the rear of the equipment for the plumbing fitting and water hose, as well as for adequate ventilation.

Leave ample room above the equipment to open and fill the product hoppers.

Water Connection



Installation of this equipment must comply with all local, state/provincial and federal codes and regulations. It is the sole responsibility of the installer to research and to comply with these codes and regulations.



The temperature of the water entering the machine must not exceed 49°C (120°F).



Accessibility to shut-off valve(s) must be provided and explained to customer in the event water supply to brewing equipment must be shut off.



For multi-unit locations whereby the main water conduit is supplying water to more than one unit (including water coolers), a separate in-line shut off valve must be installed onto each individual equipment unit.



The Eccellenza Momentum™ is factory-equipped with an integrated backflow prevention check valve. An additional external backflow prevention system is not necessary.

Water Filter

We recommend the use of a high quality water filter which eliminates most odors present in water, and reduces the amount of particles entering the water tank.

When installing a water filter, refer to the water filter manufacturer's installation instructions.



When the filter is installed or replaced, make sure to write the installation date in the provided area on the filter cartridge. Always follow the manufacturer's recommendations for filter replacement intervals.

Starting the Equipment

The main power switch for the Momentum™ is located at the rear of the machine, on the right side. To switch the power ON, toggle the power switch to the "I" position.



The Eccellenza Momentum™ now goes through a quick initialization process, after which, it is ready to be used.

Service Power Switch

The Eccellenza Momentum™ is also equipped with a secondary power switch (Service Switch) inside the machine, to the left of the coffee dispenser. This switch can be used to shut off the machine power should the main power switch be inaccessible.



The Touch Screen



①	Available beverage list
②	Hot Water option
③	Vending price and credit information (if applicable)
④	Language selection
⑤	Notifications
⑥	Shows currently selected beverage
⑦	Coffee blend selections
⑧	Cup size and coffee strength selection area
⑨	Start button - begins beverage preparation cycle
⑩	QR Code for Keurig® Remote Brew App (Touchless)

Selecting and Dispensing a Beverage Using the Touchscreen

1. Place your cup or mug on the cup stand at the bottom of the door and select the type of beverage desired.
2. Select the coffee type for the beverage that was initially selected.
3. Chose the cup size and the strength (if applicable) for the beverage that you selected.
4. Make your payment (if the Momentum™ is in vending mode).
5. Press the '**POUR**' button to begin the beverage preparation cycle.
6. Remove your cup or mug, and enjoy your delicious beverage!

Selecting and Dispensing a Beverage Using Keurig® Remote Brew App (optional Touchless Kit required)

1. Place your cup or mug on the cup stand at the bottom of the door.
2. Using your camera app on your iPhone or Android smart phone, scan the QR code that appears on the screen of the machine.

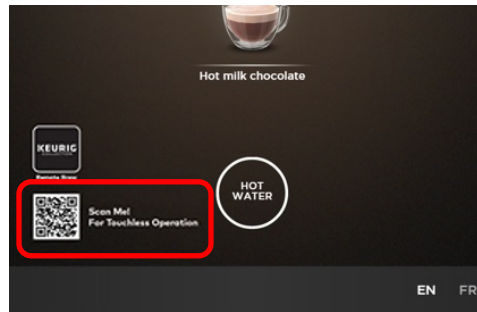

Your phone will be directed to either the Apple App Store or to Google Play where you can download and install the “Remote Brew” App.

If the app is already installed on your smartphone, scanning the QR code opens the app on your phone.



3. Tap the options icon to change the language – English, French and Spanish are available.
4. Tap the yellow bar on the ‘Remote Brew’ app.
5. Select the desired beverage.
6. Select the coffee type (if applicable).
7. Chose the cup size and the strength (if applicable) for the beverage that you selected.
8. Tap the 'Brew' button to begin the brewing or dispensing cycle.
9. Remove your cup or mug and enjoy your delicious beverage!

 The application layout may differ slightly depending on the type of smartphone being used and/or the smartphone screen size.

Filling the Coffee Bean Dispensers



The Momentum™ comes pre-configured as follows:

Coffee 1 – French Roast, Coffee 3 – Decaf, Coffee 2 – Colombian

Should you prefer a different configuration, you can reconfigure the coffee blend names in the 'Setup' menu ([see page 68](#)).



Do NOT pack the coffee beans into the dispensers!



1. Unlock and lift the coffee lid
2. Fill the dispensers with the desired coffee beans.
3. Close and lock the coffee lid.



If the dispensers are completely empty, you need to make a few vends until the dispensers are properly primed.



Any ingredient references made in this manual are for example purposes only. The actual products used in the equipment may differ from the examples used in this manual.

Filling the Powder Dispensers



The Momentum™ comes pre-configured as follows:

Powder 1 – Hot Chocolate

Powder 2 – French Vanilla

*Powder 3 – Milk**



Do NOT pack the powder into the dispensers!

***Do NOT use coffee whitener instead of milk as it may create blockages in the whipper system!**



To fill the powder dispensers, unlock and lift the main powder lid, remove the individual lid and fill the respective dispenser with the desired powder product. Once filled, **re-install the individual lid back onto the dispenser** and proceed to the next dispenser, if required.



If the dispensers are completely empty, you'll need to make a few vends until the dispensers are properly primed. During this time, you may notice dispenser-related errors on the screen - these errors will clear automatically once the dispenser is primed.



Any ingredient references made in this manual are for example purposes only. The actual products used in the equipment may differ from the examples used in this manual.

Setting the Cup Stand Overflow Detection

By default, the overflow detection for the cup stand is set at approximately 8-oz. This means that when 8-oz of liquid have accumulated in the cup stand, the “Empty Cup Stand” message appears on the screen. To increase the amount of liquid in the cup stand to 24-oz before the message appears, remove the thick o-ring from the bottom of the detector on the left side, and move it to the top (**between** the connector and the metal support), where it will act as a spacer and raise the detector.

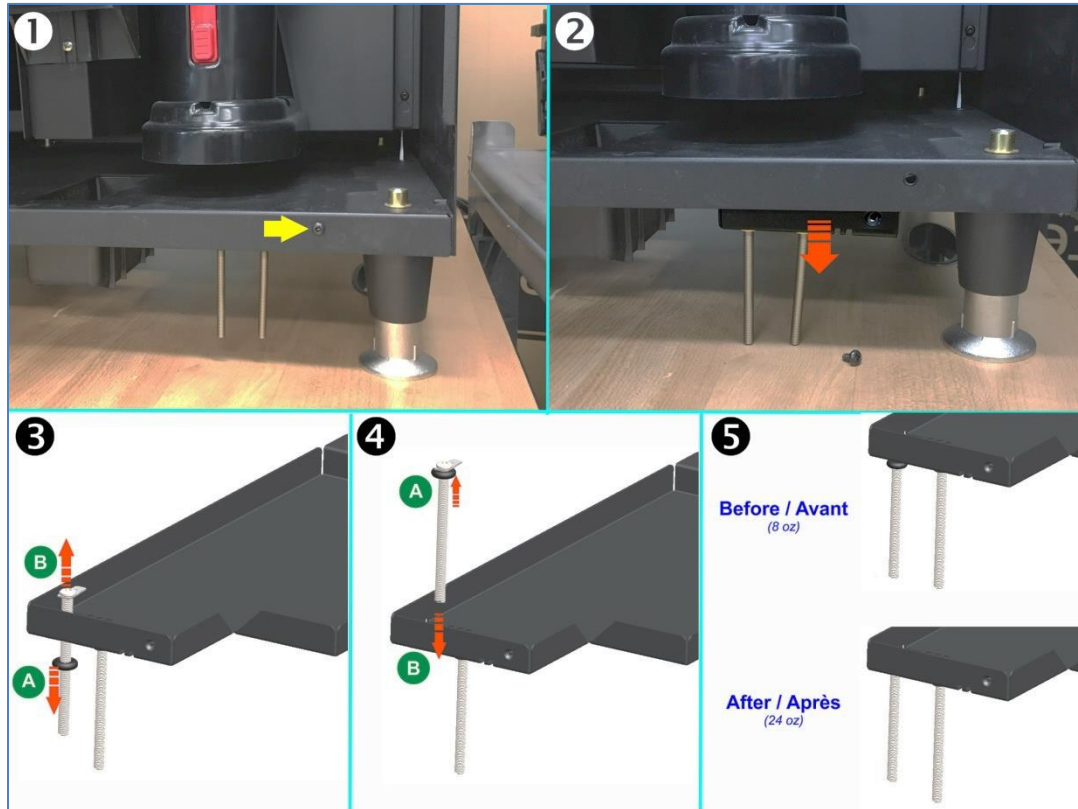

Installing a Cup Stand Drain

Alternatively, you can drill open the drain fitting at the rear of the cup stand to install a drain hose that can be routed either into a large waste bin under the cabinet (easily done if a waste chute system is used) or into an actual drain.

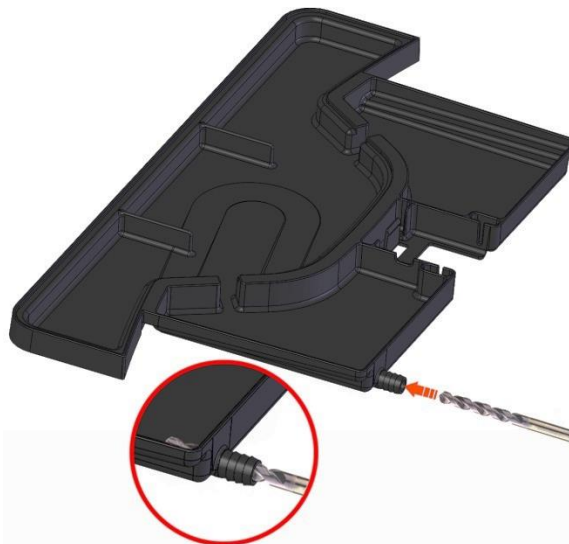

Checking Water Temperature

To check the current water temperature in the hot water tank, remove and re-install the waste bin. The machine will display the water temperature in the lower center of the screen during re-initialization.

Initial Adjustments

Change PINs for the Operator and Administrator

To prevent unauthorized access to the Momentum™ programming, we highly recommend that you change the default PIN (Personal Identification Numbers) for both the Operator and Administrator.

Both PIN numbers can be changed in the '**Security**' menu ([see page 88](#)).

Setting the Date and Time

Enter the set up of the machine and **set the correct date and time**. This is necessary when using the beverage counters, setting the Energy Savings features, tracking data that the equipment has collected and when reports are sent to the operator of the equipment.

The date and time settings are found in the '**General Settings**' menu ([see page 41](#)).

Water Levels

The Momentum™ is factory preset to dispense 12-oz, 16-oz, and 20-oz cups sizes. The water levels can be fine-tuned in the 'Setup' menu ([see page 65](#)).

Gram Throws

You will also need to calibrate the gram throws for the coffee blends and powder types you will be using in the equipment. Calibration ensures that the equipment delivers the best tasting beverage possible.

Product settings are adjusted in the '**Setup**' menu ([see page 65](#)).

Beverages

The Momentum™ is preset with all of the beverages and beverage options (such as cup sizes and strengths) enabled.

Beverage options are set in the '**Setup**' menu ([see page 65](#)).

Notifications

The Momentum™ can be configured to provide notifications about usage and consumption, counters, faults and messages, etc.

To configure the '**Notifications**' feature, go to the '**Network**' menu ([see page 57](#)).



The following symbol is used to identify a "touch" location on the machine's touch screen.

Clearing Error and Reminder Messages

Should an error or reminder message be triggered, the error or message is displayed at the lower left of the screen. In the example below, the message reads "**Please reinsert waste bin**". However, in our example, there are three messages present, as indicated by the number "3" in the upper right corner of the screen. Messages are stacked in the order in which they occur.



In this case, the waste bin has been removed and its presence is not detected. The waste bin must be replaced to clear this message.

In a case where multiple messages are present, after clearing the first message, any subsequent messages are displayed (one at a time) until they are all cleared.



If a "Call for Service" error is displayed, you need to go to the "System Status" menu to get more details about the error.

System Status Report Screen

The System Status Report screen provides a quick snapshot of the equipment’s serial number and other important information. If contacting VKI for technical assistance, you may be asked to send a photo of the **System Status Report** screen as it may prove useful during equipment troubleshooting.

To access the System Status Report screen:

1. Touch and hold the upper left corner of the screen for five seconds.



2. A screen with a numeric keypad opens. At the top of the screen, tap on the “**System Status Report**” option.

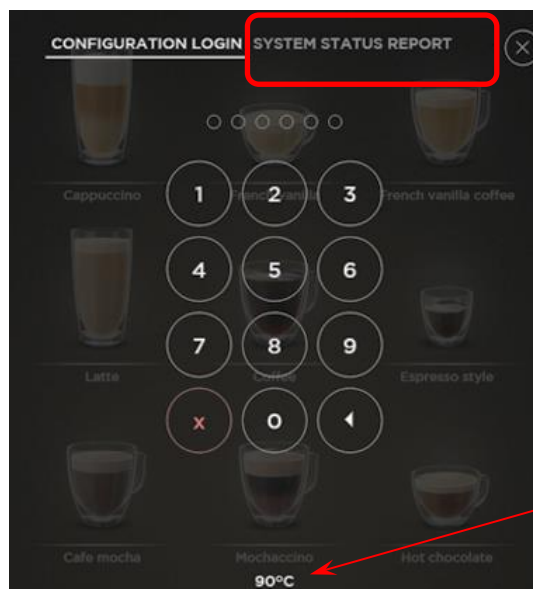

Temperature



You can also check the temperature of the water in the hot water tank at any time by accessing this screen.

3. The “**System Status Report**” screen opens to provide a quick snapshot of the machine’s most important information. This includes:
- the serial number and other unique identifiers
 - current temperature
 - some maintenance information
 - active errors and logs
 - software, firmware and OS information
 - product counters
 - resource usage

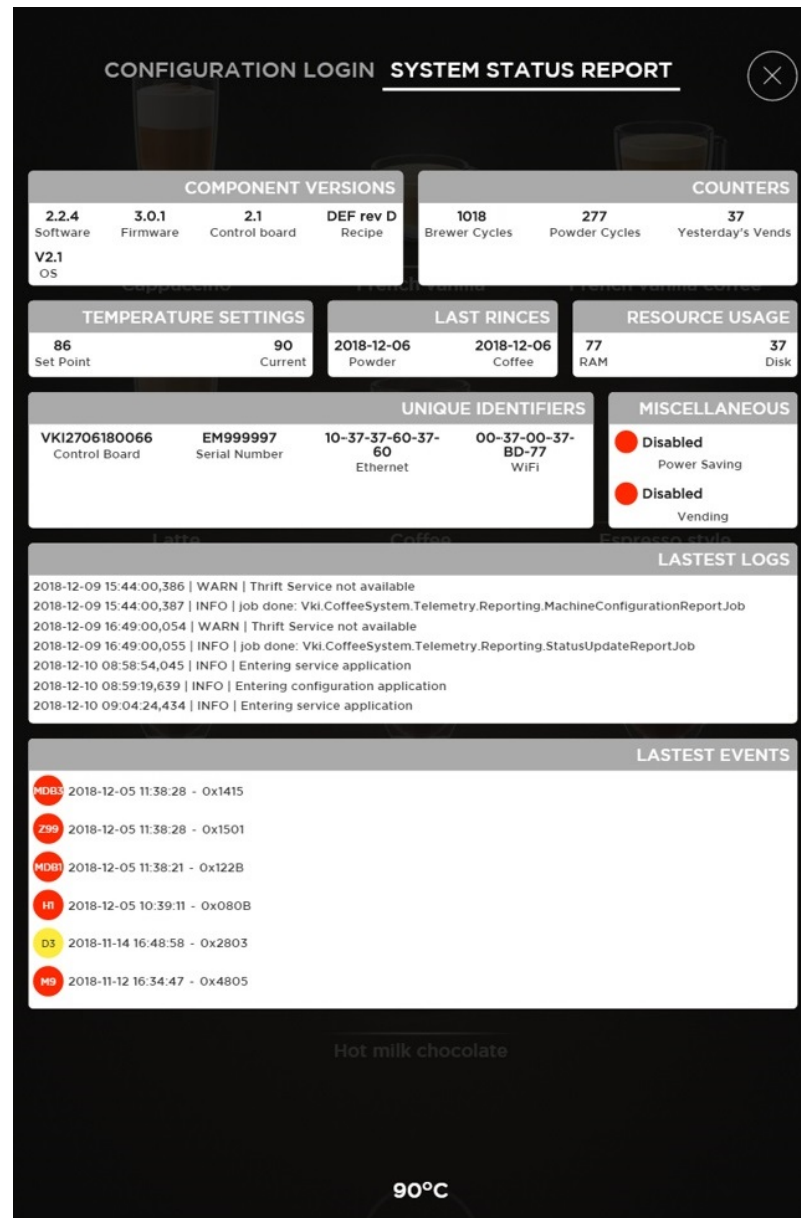

As previously stated, you may be asked to send a photo of the System Status Report screen to VKI Technical Support as it may prove useful during equipment troubleshooting.

SECTION 3

Configuring the Equipment



The following symbol is used to identify a "touch" location on the machine's touch screen.

Accessing the Configuration System

To access the equipment Configuration System:

1. Touch and hold the upper left corner of the screen for five seconds.



2. A numeric keypad opens and you are required to enter your personal identification number (PIN).

The default PIN for the **Operator** is '345678'. The default PIN for the **Administrator** is '234567'. See the '**Security**' section ([page 88](#)) for more information.



3. If the correct PIN is entered, the **'System Status'** screen shown below opens. If an incorrect PIN is entered, it remains on the keypad screen.

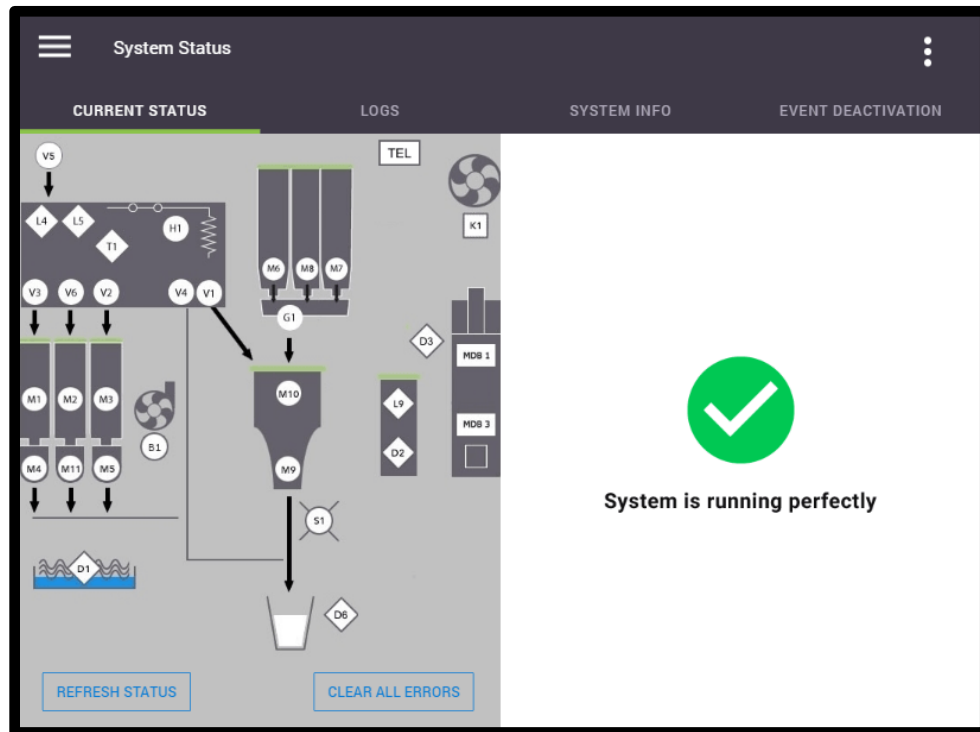

If logging in as an Operator, all menus will be visible as you have full rights/access to the programming mode. If logging in as an Administrator, your rights/accesses may be limited and some menus may not be accessible.



Your PIN must remain confidential, therefore you should never disclose your PIN to anyone.

Programming Menu Structure

The Setup menu drop-list can be viewed at any time by touching the triple-bar icon on the upper left side of the screen. When the drop-list is open, simply touch the required setting on the list to open the corresponding configuration menu.

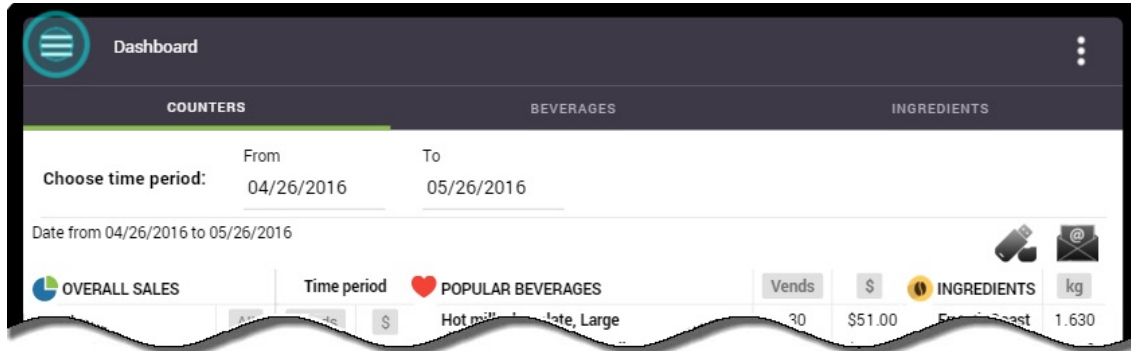

Menu Drop-List Overview

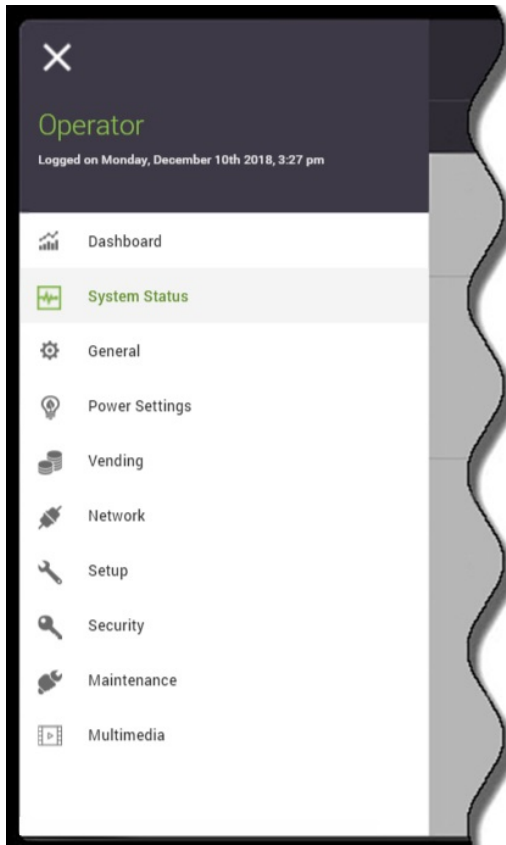

Dashboard - displays statistics on consumption, counters, and sales.

System Status - displays the status of the machine (including current faults) and provides logs of previous faults.

General Settings - set language, units and date/time, set speaker volume and screen brightness.

Power Settings - set energy saving features.

Vending / Pricing - enable vending and set pricing

Network - configure network connections, email notifications and telemetry.

Setup - enable and rename products and beverages, set recipes and timings, set temperature, fine-tune water settings, and product calibrations.

Security - assign/change PIN numbers, and grant or remove access to individual sections of the machine programming.

Maintenance – perform maintenance and test each component individually for functionality.

Multimedia – load custom images and video



All of the menus and tabs in this section will only be visible to anyone that logs in as an **Operator**. If you log in as an **Administrator**, you may **not** have access to all of these menus and tabs. See the "Security" section ([page 88](#)) for more information.

Sub-Menu Tabs

Some of the settings in the drop-down list also contain sub-menus. If you want to view a sub-menu, select (tap) one of the sub-menu tabs at the top of the screen.

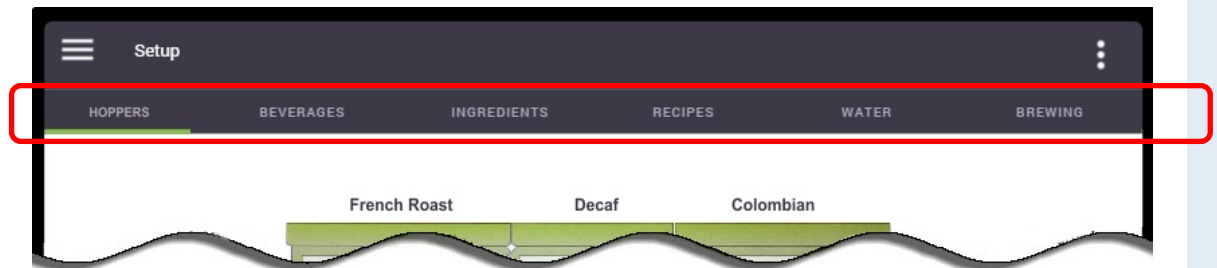

If multiple tabs are available, the currently active tab is identified by a green line directly beneath the sub-menu name, which also appears white instead of gray.



Exiting the Setup

To exit the Setup at any time, touch the three dots on the top right corner. This opens the "Log Off" tab that closes the Setup.

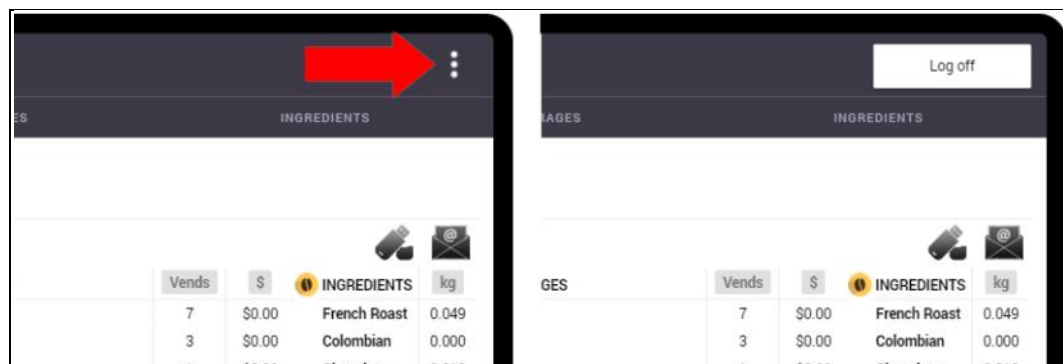

Dashboard

The Momentum™ 'Dashboard' displays statistics on counters, consumption, and sales (vending).

Counters

The 'Counters' tab displays a view of the internal counters in the machine. The counters provide a snapshot of the machine's consumption and sales. **Please note that these counters are displayed based on the time period chosen and are non-resettable.**

The screenshot shows the 'Dashboard' interface with the 'COUNTERS' tab selected. It features several data sections:

- Time Period:** A selection box at the top left, highlighted with a red box and number 1, showing 'From: 04/26/2016' and 'To: 05/26/2016'.
- Overall Sales:** A table with columns for 'All', 'Vends', and '\$'. It lists categories like 'Total', 'Specialty beverages', 'Powder Only', and 'Coffee Only'.
- Popular Beverages:** A table listing items like 'Hot milk chocolate, Large', 'Coffee French Roast, Medium', etc., with columns for 'Vends' and '\$'.
- Ingredients:** A table listing items like 'French Roast', 'Colombian', 'Chocolate', etc., with columns for 'Vends' and '\$'.
- Maintenance:** A section showing 'Remaining Powder Vends Before Powder Rinse' (63) and 'Remaining Coffee Vends Before Brewer Rinse' (486).
- Cashbox:** A section showing 'Credits - Time period' (\$202.55), 'Credits - Current' (\$41.50), and 'Credits - Last Reset' (\$119.55).
- Save or Email Information:** Icons for a USB drive and an email symbol, highlighted with a red box and number 3.

- ❶ **Time Period:** allows you to select the time period for which to display the counters or statistics.
- ❷ **Overall Sales:** displays the overall beverage sales (in cups) for the selected time period. Also displays sales information for 'Popular Beverages'.
- ❸ **Save or Email Information:** allows you to save the information to a USB flash drive, or to send it by email (in Microsoft Excel format).
- ❹ **Ingredients:** displays the overall product sales (by weight) for the selected time period.
- ❺ **Maintenance:** displays how many 'coffee' or 'powder' vends remain before an automated brewer rinse or powder rinse request is activated.
- ❻ **Cashbox:** displays the 'Cashbox' information (if applicable) for the selected time period.

To specify the time period for which you want to view the data:

1. Tap on the **"From"** field and enter the desired month, date and year and tap **"Done"**.

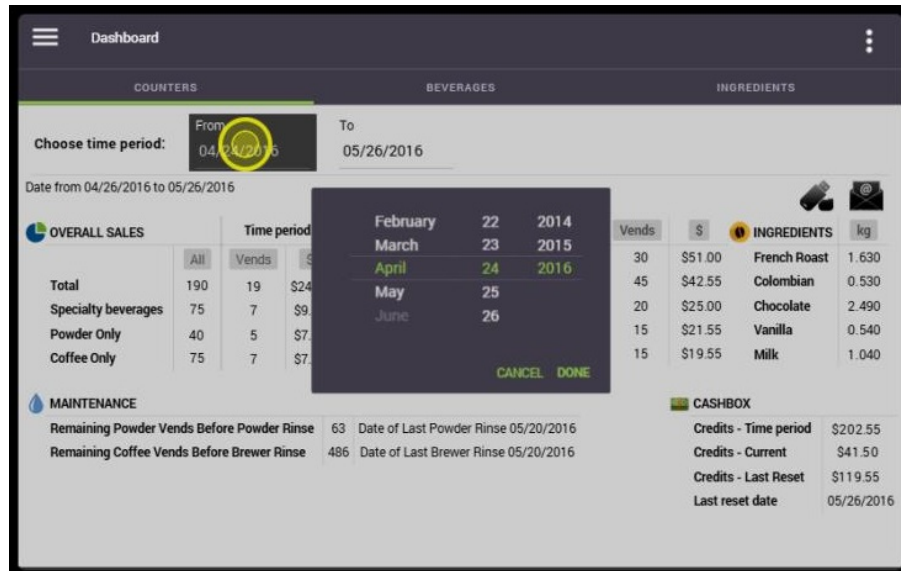

2. Tap on the **"To"** field and enter the desired month, date and year and tap **"Done"**.

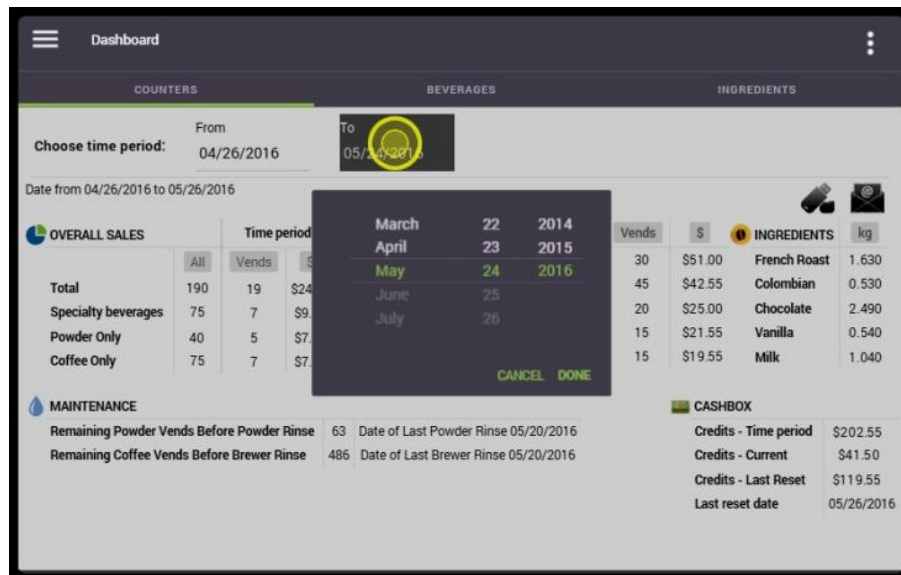

- The screen now displays the statistics for the time period selected.

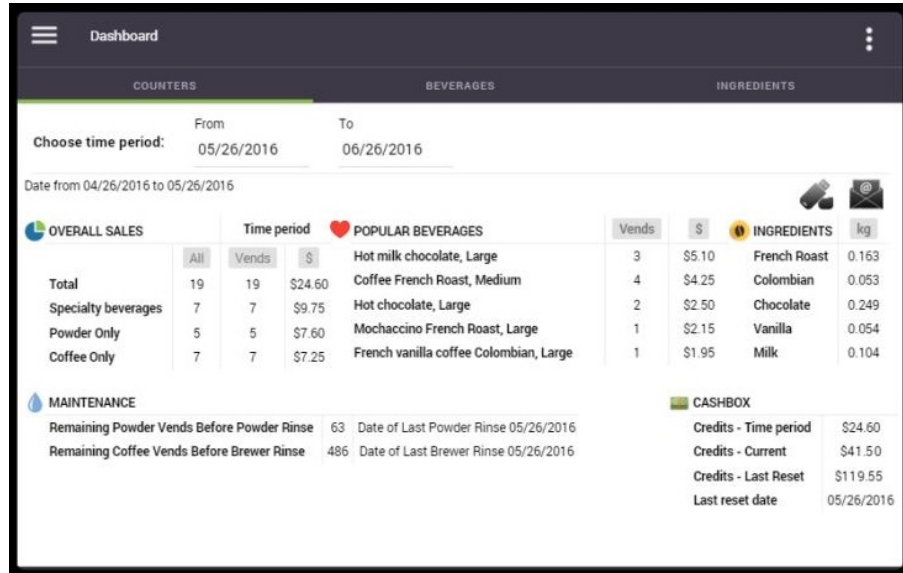

Beverages Tab

The 'Beverages' tab allows you to select and view the consumption (by cups) for a specific time period for each of the individual beverages the equipment dispenses. To specify the time period:

- Tap on the "From" field and enter the desired month, date and year and tap "Done".

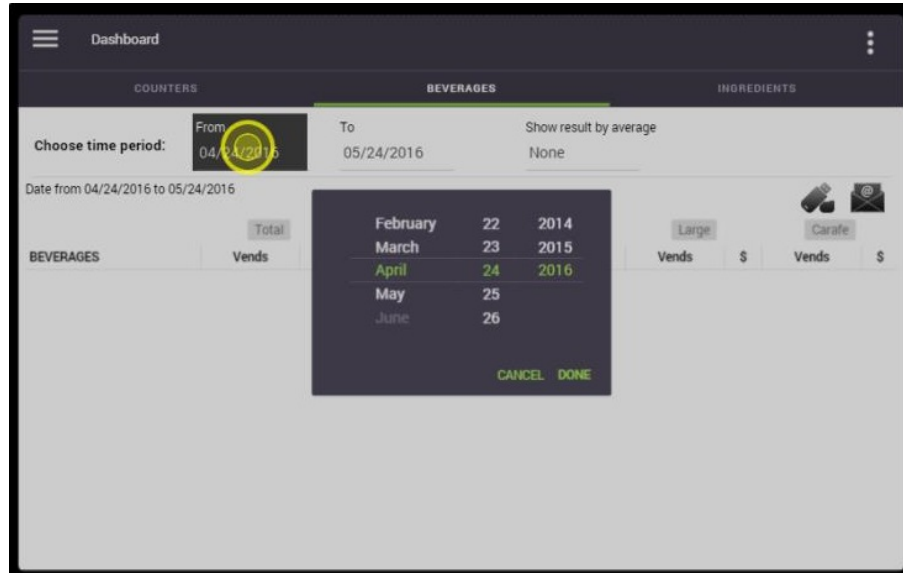

- Tap on the "To" field and enter the desired month, date and year and tap "Done".

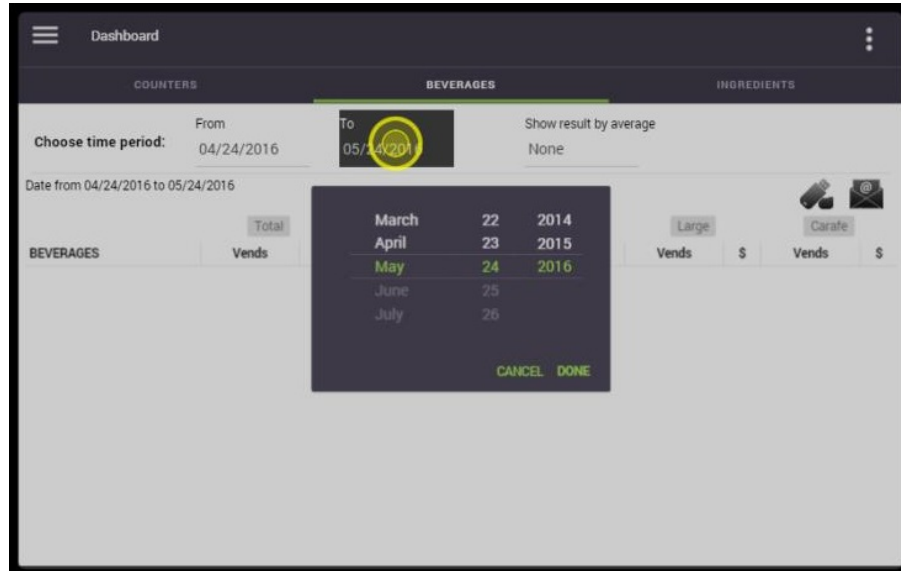

- The number of cups brewed and the amount of money collected (if applicable) are displayed for the time period that was selected.

The screenshot shows the 'Dashboard' interface with the 'BEVERAGES' tab selected. The 'Choose time period' section shows 'From' as 04/27/2016 and 'To' as 05/27/2016. The 'Show result by average' field is highlighted with a red box and contains the value 'None'. Below this is a table showing beverage sales data for the selected time period.

BEVERAGES	Total		Small		Medium		Large		Carafe	
	Vends	\$	Vends	\$	Vends	\$	Vends	\$	Vends	\$
✓ Coffee	6	\$6.25	0	\$0.00	5	\$5.25	1	\$1.00	0	\$0.00
✓ Cappuccino	1	\$1.00	0	\$0.00	0	\$0.00	1	\$1.00	0	\$0.00
✓ Cafe Mocha	2	\$2.65	1	\$1.00	1	\$1.65	0	\$0.00	0	\$0.00
✓ Espresso Style	1	\$1.00	0	\$0.00	0	\$0.00	1	\$1.00	0	\$0.00
✓ Mocaccino	2	\$3.15	0	\$0.00	1	\$1.00	1	\$2.15	0	\$0.00
✓ Hot chocolate	2	\$2.50	0	\$0.00	0	\$0.00	2	\$2.50	0	\$0.00
✓ French vanilla coffee	2	\$2.95	0	\$0.00	0	\$0.00	2	\$2.95	0	\$0.00
✓ Hot milk chocolate	3	\$5.10	0	\$0.00	0	\$0.00	3	\$5.10	0	\$0.00

If you would prefer to view the results as a Daily, Weekly or Monthly average, you can change the parameter in the 'Show result by average' field.

- Tap on the green "down" arrow beside any of the beverages shown to expand the selections for a more thorough breakdown of the data shown.

For example, the "Coffee" field shows 6 cups. Tapping on the green "down" arrow beside 'Coffee' shows you that of the 6 cups brewed, 4 were French Roast, 1 was Colombian and 1 was House Blend. This procedure can be performed on any of the beverages listed.

BEVERAGES		Total		Small		Medium		Large		Carafe	
		Vends	\$	Vends	\$	Vends	\$	Vends	\$	Vends	\$
☑ Coffee		6	\$6.25	0	\$0.00	5	\$5.25	1	\$1.00	0	\$0.00
French Roast	Regular	4	\$4.25	0	\$0.00	4	\$4.25	0	\$0.00	0	\$0.00
Colombian	Regular	1	\$1.00	0	\$0.00	0	\$0.00	1	\$1.00	0	\$0.00
House Blend	Regular	1	\$1.00	0	\$0.00	1	\$1.00	0	\$0.00	0	\$0.00
☑ Cappuccino		1	\$1.00	0	\$0.00	0	\$0.00	1	\$1.00	0	\$0.00
☑ Cafe Mocha		2	\$2.65	1	\$1.00	1	\$1.65	0	\$0.00	0	\$0.00
☑ Espresso Style		1	\$1.00	0	\$0.00	0	\$0.00	1	\$1.00	0	\$0.00
☑ Mocaccino		2	\$3.15	0	\$0.00	1	\$1.00	1	\$2.15	0	\$0.00
☑ Hot chocolate		2	\$2.50	0	\$0.00	0	\$0.00	2	\$2.50	0	\$0.00
☑ French vanilla coffee		2	\$2.95	0	\$0.00	0	\$0.00	2	\$2.95	0	\$0.00
☑ Hot milk chocolate		3	\$5.10	0	\$0.00	0	\$0.00	3	\$5.10	0	\$0.00

Here is an example with the 'French Vanilla Coffee' selection expanded.

BEVERAGES		Total		Small		Medium		Large		Carafe	
		Vends	\$	Vends	\$	Vends	\$	Vends	\$	Vends	\$
☑ Coffee		6	\$6.25	0	\$0.00	5	\$5.25	1	\$1.00	0	\$0.00
☑ Cappuccino		1	\$1.00	0	\$0.00	0	\$0.00	1	\$1.00	0	\$0.00
☑ Cafe Mocha		2	\$2.65	1	\$1.00	1	\$1.65	0	\$0.00	0	\$0.00
☑ Espresso Style		1	\$1.00	0	\$0.00	0	\$0.00	1	\$1.00	0	\$0.00
☑ Mocaccino		2	\$3.15	0	\$0.00	1	\$1.00	1	\$2.15	0	\$0.00
☑ Hot chocolate		2	\$2.50	0	\$0.00	0	\$0.00	2	\$2.50	0	\$0.00
☑ French vanilla coffee		2	\$2.95	0	\$0.00	0	\$0.00	2	\$2.95	0	\$0.00
House Blend	Strong	1	\$1.00	0	\$0.00	0	\$0.00	1	\$1.00	0	\$0.00
Colombian	Strong	1	\$1.95	0	\$0.00	0	\$0.00	1	\$1.95	0	\$0.00
☑ Hot milk chocolate		3	\$5.10	0	\$0.00	0	\$0.00	3	\$5.10	0	\$0.00

Ingredients Tab

The 'Ingredients' tab displays the consumption (in weight) for each of the ingredients used (as well as the volume of water used) to prepare the beverages the equipment dispenses.

Ingredient	Weight (kg)
French Roast	1.630
Colombian	0.750
Decaf	0.220
Chocolate	2.490
Vanilla	0.680
Milk	1.640
Water	24.655 L

Emailing Data or Saving it to a USB Flash Drive

All of the data available in the Momentum™ Dashboard can either be saved to a USB flash drive, or sent to an email address as an attachment (if an email address has been set in the "Network" menu). Whether saved to a USB drive or sent by email, the attachment is in Microsoft Excel format.

To save the data to a USB drive, tap on the USB drive icon on the left. To send it by email, tap on the email icon (envelope) on the right, and follow the prompts on the screen.

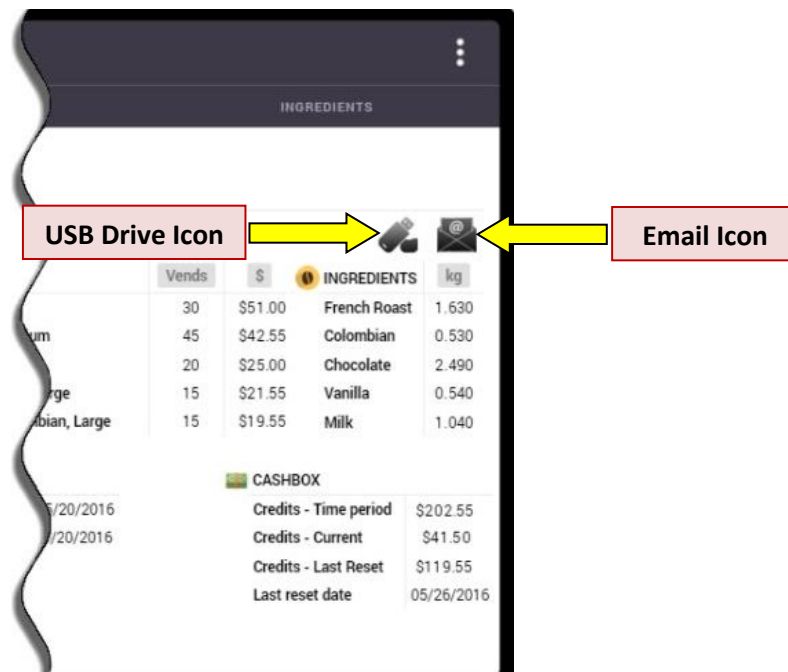

System Status

The 'System Status' screen displays the status of the machine (including current faults) and provides logs of previous faults. The equipment system info (such as serial number, firmware version, IP address, etc.) and maintenance functions are also found here.

Current Status

The machine's current operating status is displayed with an easy-to-read graphic. If the system is functioning properly (with no faults detected), a green checkmark is displayed (see image below).

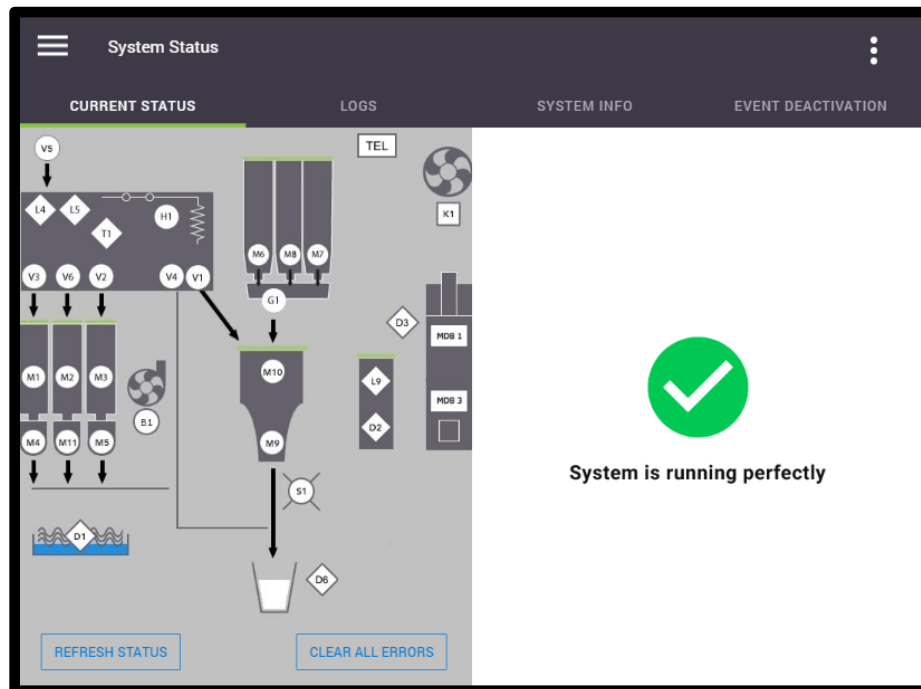

Fault Codes

Should a fault be present, it is identified in the "Current Status" tab, under the "**System Status**" menu, using one of the codes from the list below. The right section of the screen shows the component code (and pending component codes) and a brief description of the fault.

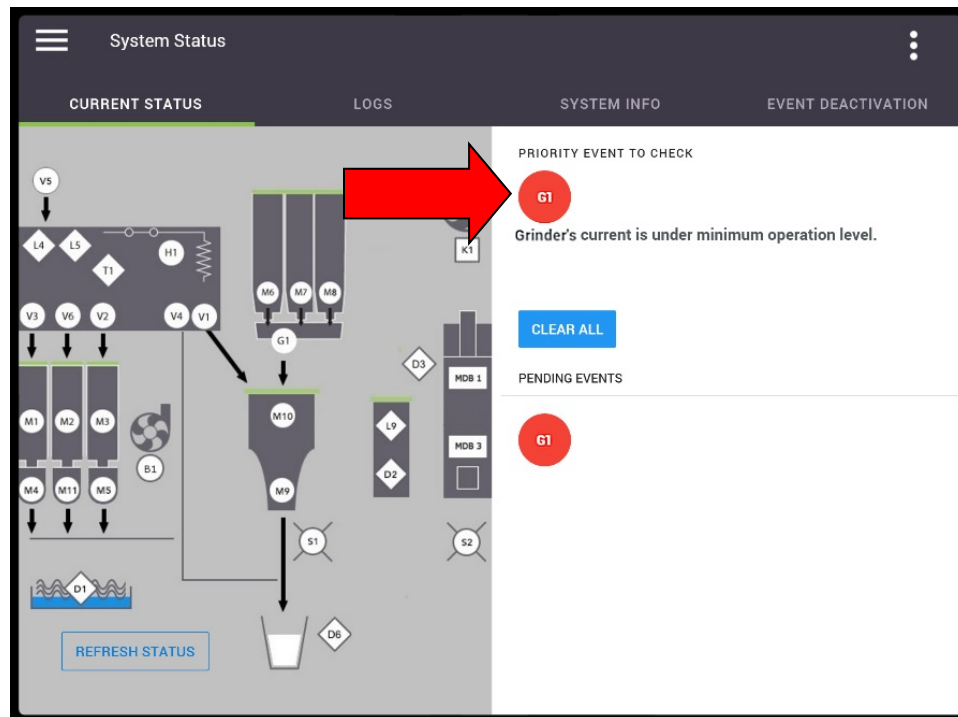

CODE	COMPONENT
B1	Blower (Powders)
D1	Tank Overflow Detection
D2	Waste Bin Presence Detection
D3	Door Open Detection
D6	Cup Detection
G1	Grinder
H1	Heating Element
K1	Exhaust Fan
L4	Normal Water Level Detection
L5	Safety Water Level Detection
L9	Waste Bin Level Detection
M1	Powder 1 Motor
M2	Powder 2 Motor
M3	Powder 3 Motor
M4	Powder 1 Whipper Motor
M5	Powder 3 Whipper Motor
M6	Coffee 1 Motor

CODE	COMPONENT
M7	Coffee 2 Motor
M8	Coffee 3 Motor
M9	Brewer Motor
M10	Brewer Wiper Motor
M11	Powder 2 Whipper Motor
S1	Cup Lighting
S2	Esthetic Lighting
T1	Temperature Probe
V1	Outlet Valve - Coffee
V2	Outlet Valve - Powder 3
V3	Outlet Valve - Powder 1
V4	Outlet Valve - Hot Water
V5	Inlet Valve
V6	Outlet Valve - Powder 2
MBD1	Coin Acceptor
MDB3	Card Reader
Z99	Miscellaneous

In the example above, a fault has been detected with "G1", which is the grinder. After correcting the error, tap the "Clear All" button. The screen then displays a green checkmark with the "System is running perfectly" message beneath it. In some cases, the error may re-appear when the machine is placed back in normal operation, at which point a more thorough troubleshooting is required.



Fault codes must be manually cleared (in this menu) after the fault has been corrected, otherwise the error message will continue to appear on the main screen.

Logs

The 'Logs' tab shows the fault history of the equipment in list form (from newest to oldest). Codes marked in Red identify that servicing was required. Yellow-marked codes warn of potential faults. Codes in green identify that the fault was corrected, and when it was corrected.

CODE	DATE	DESCRIPTION
Z99	34 minutes ago	All errors cleared
H1	36 minutes ago	Heater's current is under minimum operation level.
Z99	36 minutes ago	All errors cleared
H1	40 minutes ago	Heater's current is under minimum operation level.
D3	21 days ago	The machine door is open.
D3	21 days ago	The machine door is open.
D3	21 days ago	The machine door is open.
D3	21 days ago	The machine door is open.
D3	21 days ago	The machine door is open.

System Info

Information about the equipment, such as serial number, firmware versions, network and MAC address, vending devices, etc., can be found in this menu.

***NOTE: The "Vending Devices" option is only visible when "Vending" is set to 'ON'.**

 The "Machine Name" field can be edited. To do so, simply tap on the machine name and the keyboard appears, allowing you to rename the machine.

Event Deactivation

The Event Deactivation tab allows you to deactivate any of the error messages that can potentially appear should the system detect a fault.



Deactivating error messages allows the equipment to continue to operate with a defective component, as a fault notification is not displayed. This, in turn, may cause further damage to the equipment and/or its surroundings.

To deactivate a particular error message:

1. Select the required component from the list of components. The table below identifies the component code.
 - a. Once a component is selected, the list of related error messages for this component is displayed under the "Event Name" heading.

CODE	COMPONENT	CODE	COMPONENT
B1	Blower (Powders)	M3	Powder 3 Motor
D2	Waste Bin Detection	M4	Powder 1 Whipper Motor
D3	Door Open Detection	M5	Powder 3 Whipper Motor
D6	Cup Detection	M6	Coffee 1 Motor
G1	Grinder	M7	Coffee 2 Motor
H1	Heating Element	M8	Coffee 3 Motor
K1	Exhaust Fan	M9	Brewer Motor
L4	Normal Water Level Detection	M10	Brewer Wiper Motor
L5	Safety Water Level Detection	M11	Powder 2 Whipper Motor
L9	Waste Bin Full Detection	S1	Cup Lighting
MDB1	Vending Devices	T1	Temperature Probe
M1	Powder 1 Motor	Z99	Various Components
M2	Powder 2 Motor		

- Under the **"Turned Off / On"** heading at the right, turn off the error to be deactivated using the slider (green slider = ON, gray slider = OFF).

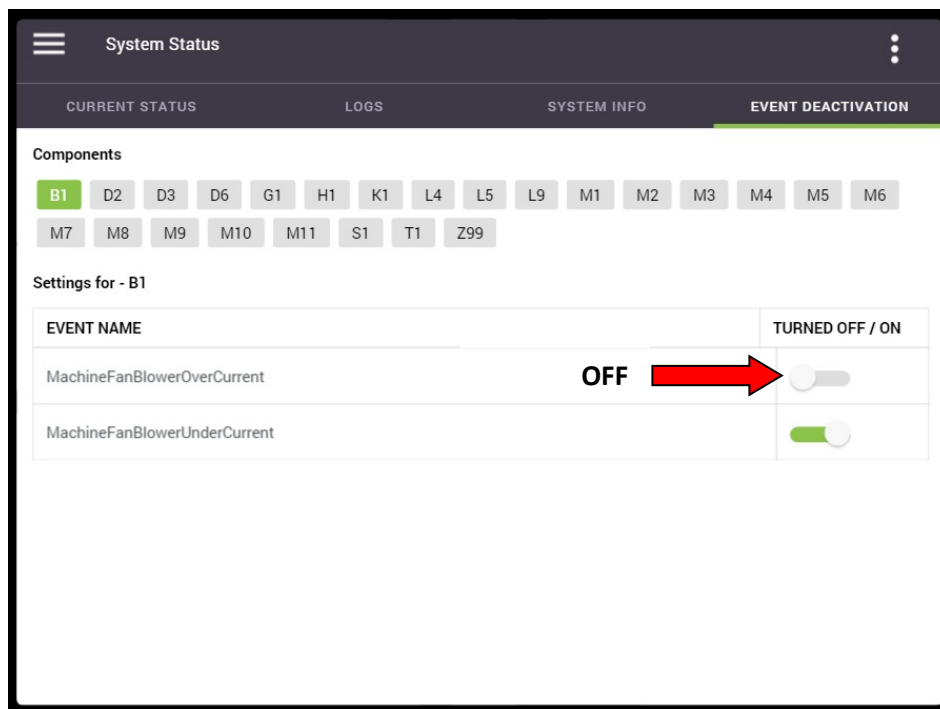
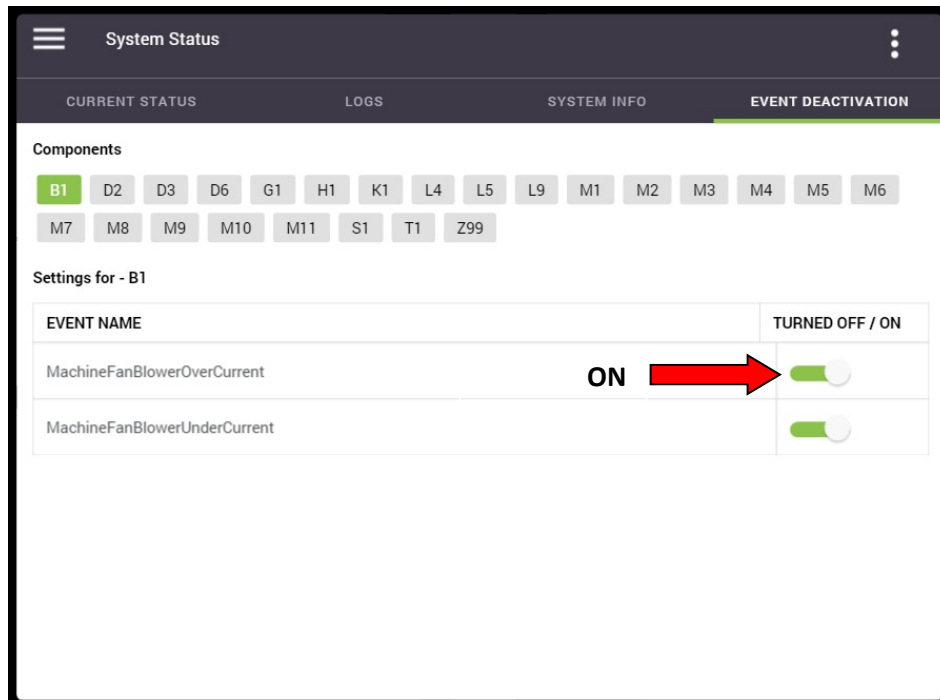

- Repeat the procedure for any other components, if necessary.

General Settings

The 'General' screen is where you can configure the waste chute system, the primary and secondary interface languages to be used, units of measure (Metric or U.S. Standard) and the date and time, as well as the display and sound settings. You can also change the frequency at which the brewer and powder rinse cycles are triggered in the "Task Schedule" tab.

Installation

Waste Management (Waste Chute)

If the machine will be equipped with the optional waste chute kit, you'll need to come to this tab and enable the 'Use Waste Chute' option. Doing so will make the wiper move from right to left, guiding the spent coffee grounds into the waste chute instead of the waste bin.

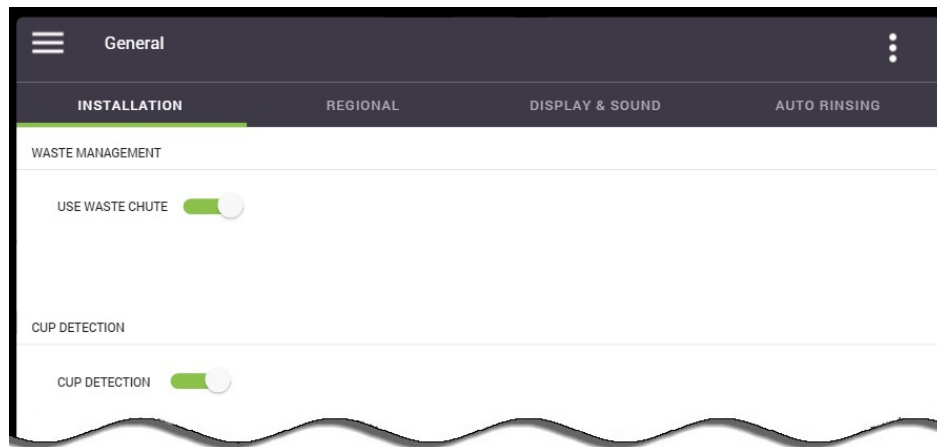

Cup Detection

The Eccellenza Momentum is equipped with a cup detection system. By default, this system is enabled. Touch the slider in this menu to disable the cup detection system.

Regional

Language

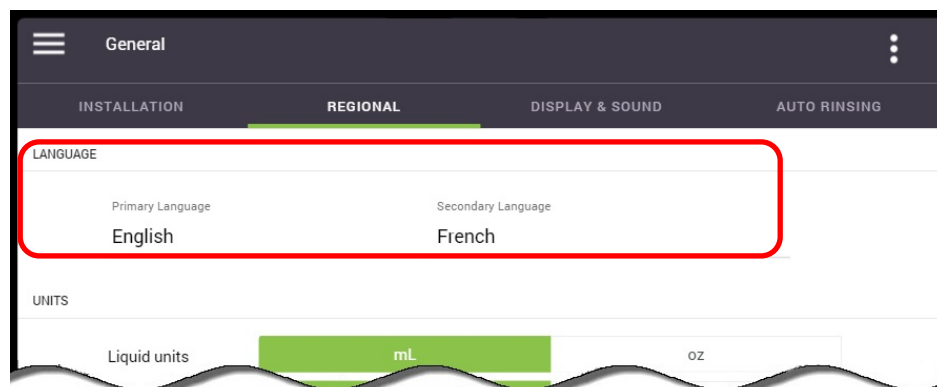

The Momentum™ comes pre-loaded with three different languages (English, French and Spanish), however **only two can be active at one time**. In this tab, you can define the Primary Language, which will be the default, and the Secondary Language, which will be selectable by the user.

To change the language settings, select either the Primary or Secondary setting, choose the required language from the list, and select 'Done'. Note that you can also select 'None' as the secondary language (see example below) should you want only one language available.

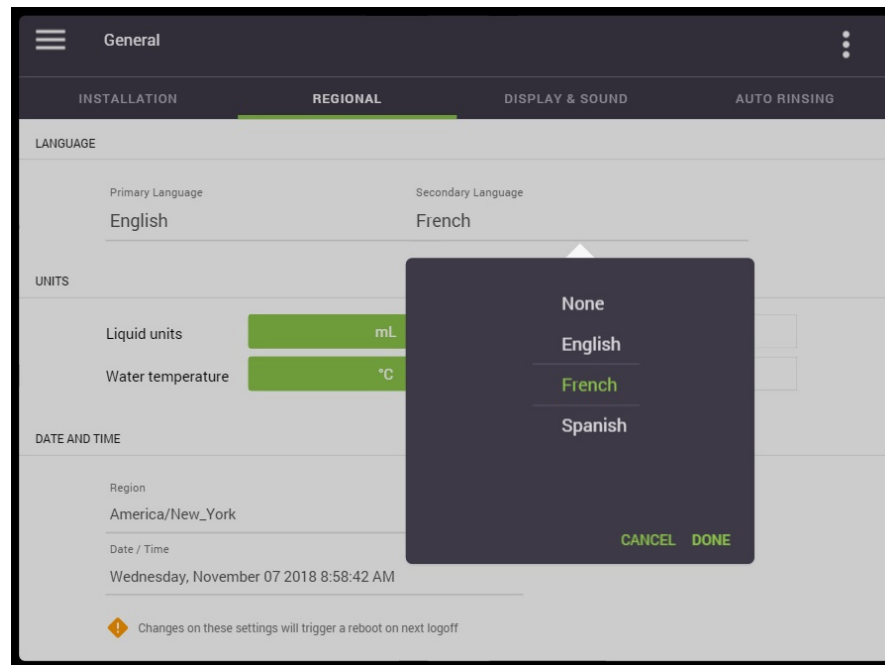

Units of Measure

The units of measure displayed by the Momentum™ can be set in this tab. Liquid units can be set to either milliliters (ml) or ounces (oz), and the temperature can be set to either °C or °F.

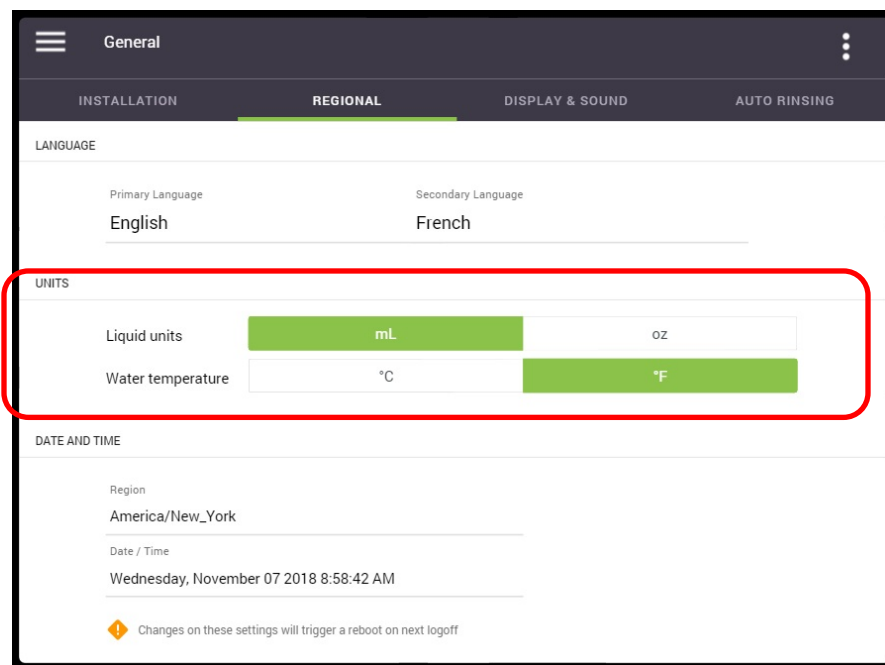



To simplify weight settings for coffees and powders, the Momentum™ only displays the units as grams when they are being set.

Date and Time



If the 'Telemetry' option is activated, the time and date will be set automatically.

To adjust the date, time and time zone setting, first, set the '**Region**' (Time Zone) in which you are located, and then select the '**Date and Time**' feature to open the scroll list.

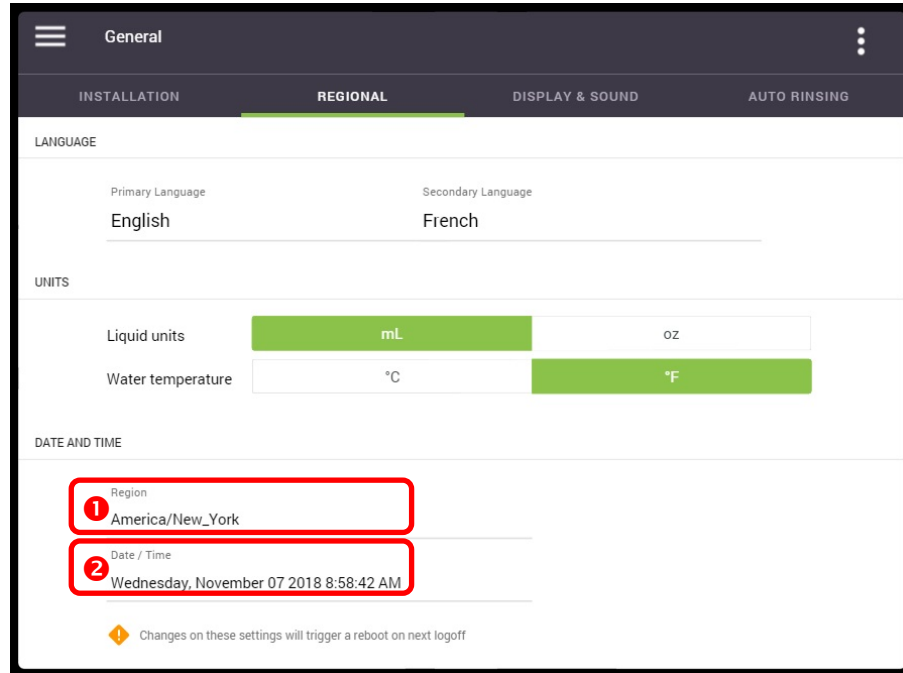

Adjust each of the '**Date & Time**' fields by scrolling up or down to the required setting. Once all are set, press '**Done**' to save the new settings. The table in the image identifies what each of the fields of the scroll list represents.

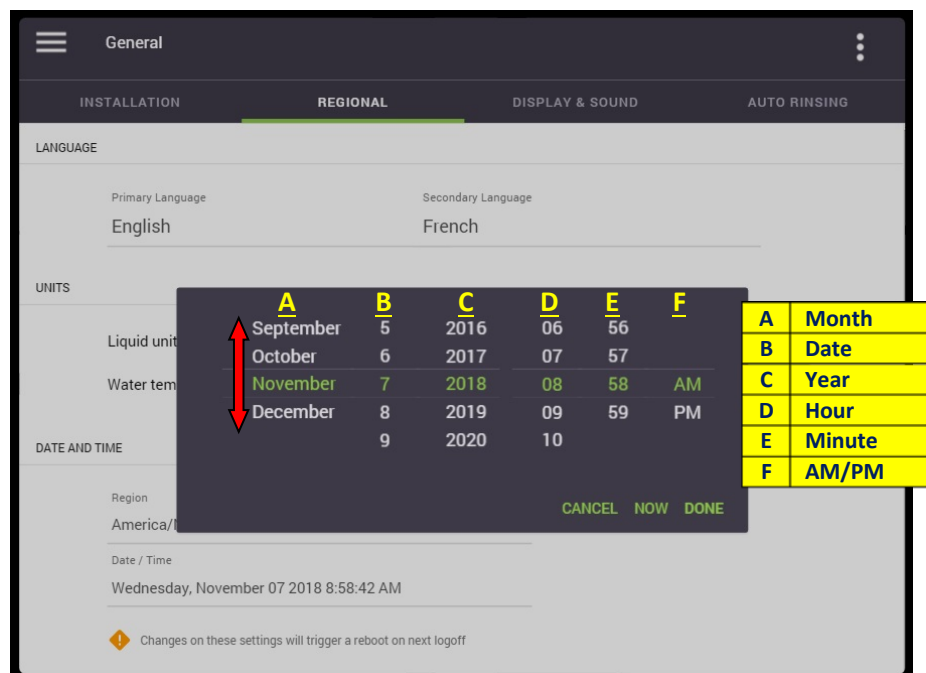

Display and Sound

This screen is used to set the volume level (available **only** when speakers are used) and the brightness of the screen.

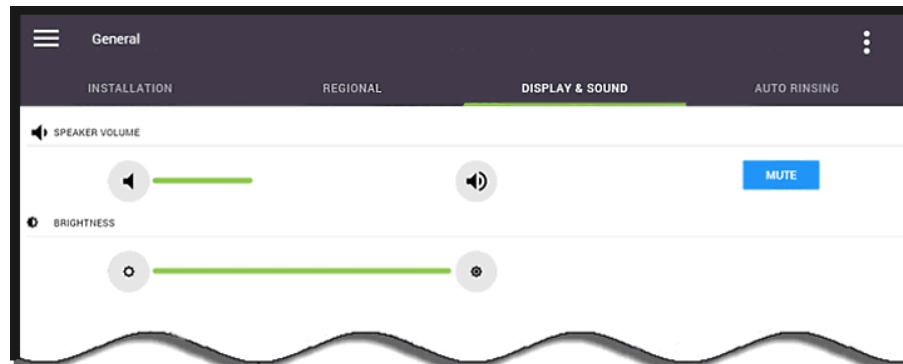

Auto Rinsing

Counter Trigger

This screen is used to set the frequency at which the notifications for **mandatory** Brewer Rinse and Powder Rinse cycles are triggered. By default, the Brewer Rinse is set to 500 cups, and the Powder Rinse is set to 75 cups.

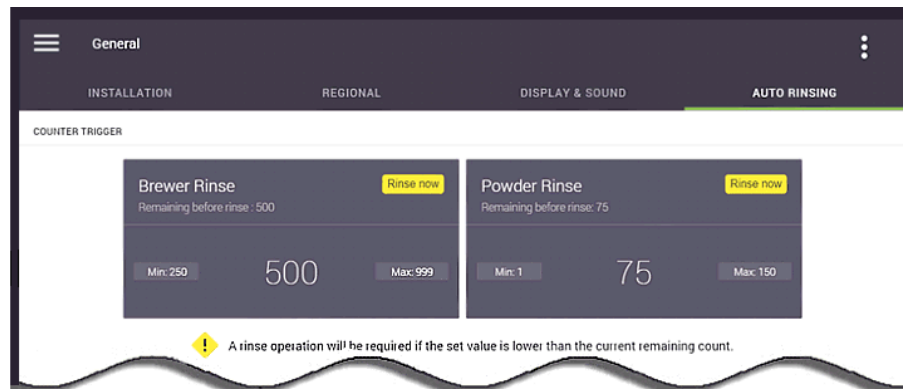

To change the frequency, tap on the desired option and input the new setting. Once you are finished, tap the 'Done' button to save your new setting.

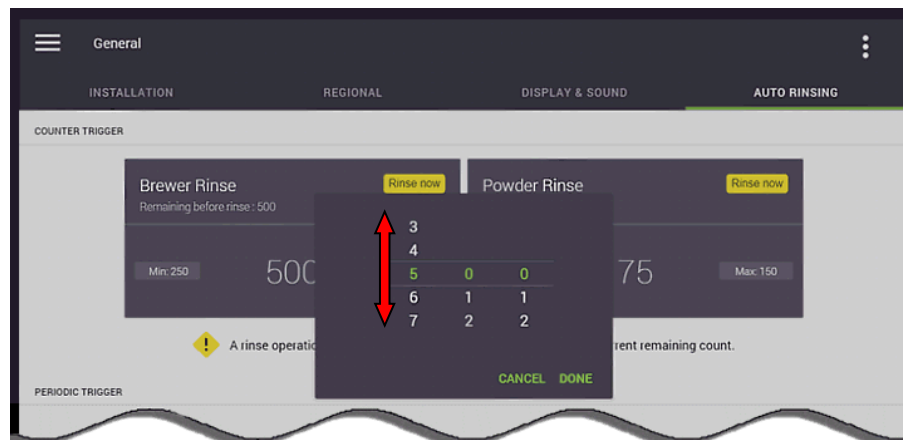

Periodic Trigger

A second option is also available for the auto-rinsing feature. It can now be triggered to activate at a pre-set time of day.

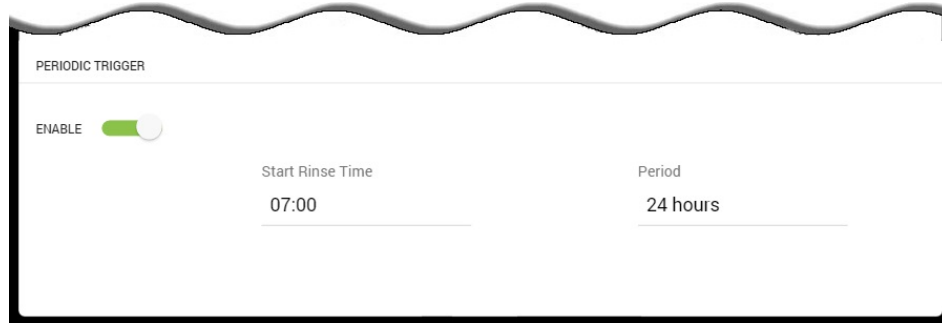

The screenshot shows a configuration menu titled "PERIODIC TRIGGER". It contains three settings: "ENABLE" with a green toggle switch, "Start Rinse Time" set to "07:00", and "Period" set to "24 hours".

The following can be configured in this menu:

- **Enable** – enable (green) or disable (gray) this feature.
- **Start Time** – set the time of day that triggers the auto-rinsing.
- **Period** – set the frequency at which the auto-rinse triggers (every 24 or 48 or 72 hours)

Power Settings

The 'Power Settings' screen is used to set the energy saving options available in the Momentum™.

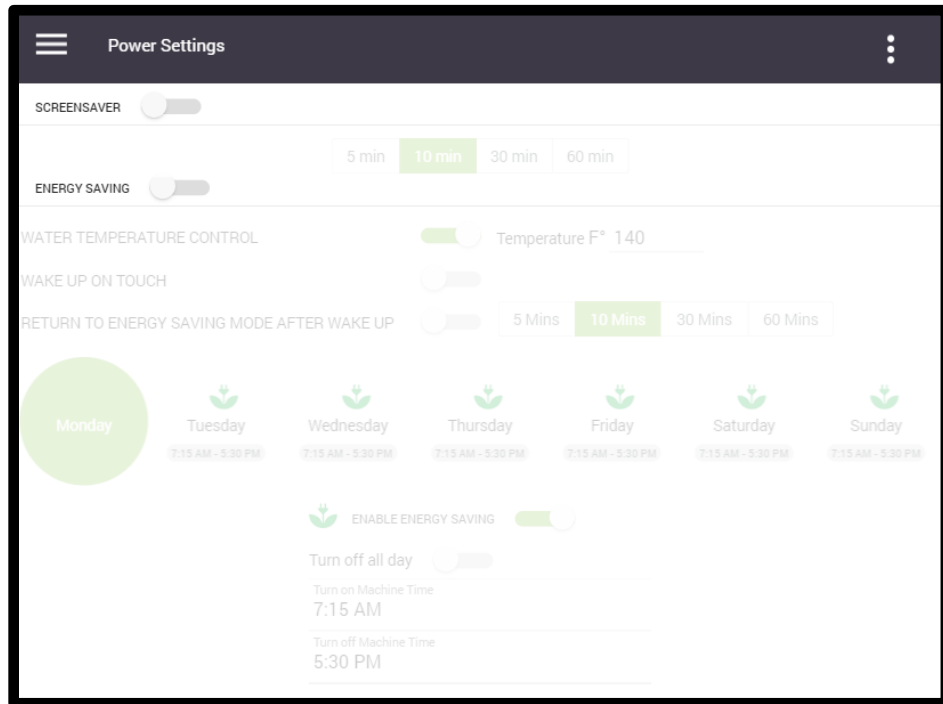

Screensaver

If the 'Screensaver' feature is activated, the screen will dim slightly after the preset amount of time to reduce energy consumption.

When activated, it will also trigger the screensaver videos to play when the machine is at idle.

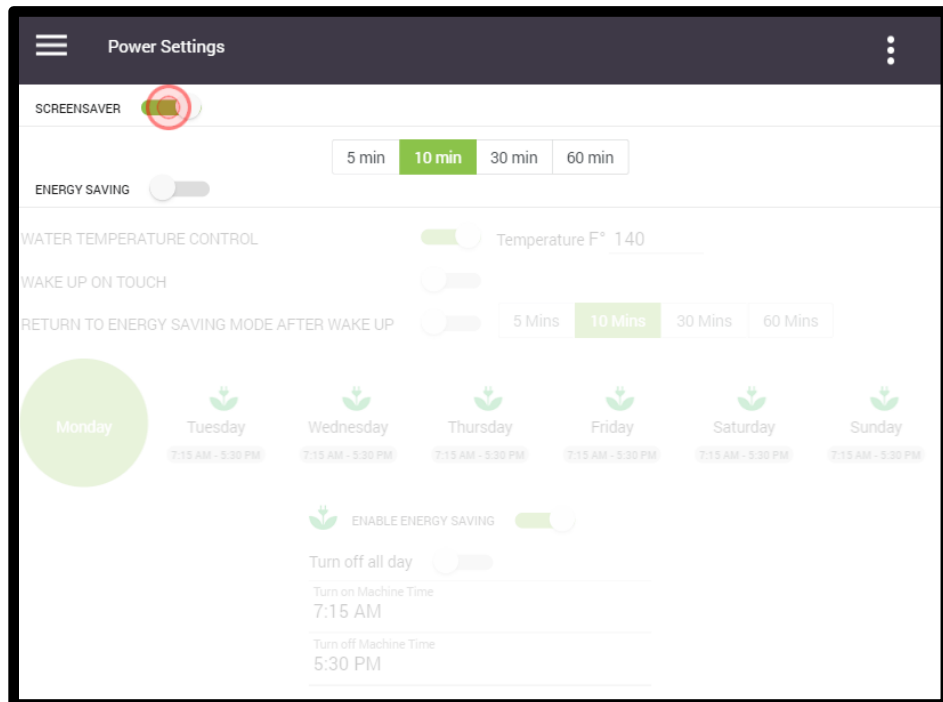

Energy Saving

To conserve energy, the Momentum™ can be set to go into an 'Energy Saving' mode during preset periods of time. While in Energy Saving mode, only the machine screen functions to advise users that the machine is in Energy Saving mode. All other components are disabled, including the heating element.

1. Tap the '**Energy Saving**' slider to activate the Energy Saving mode.

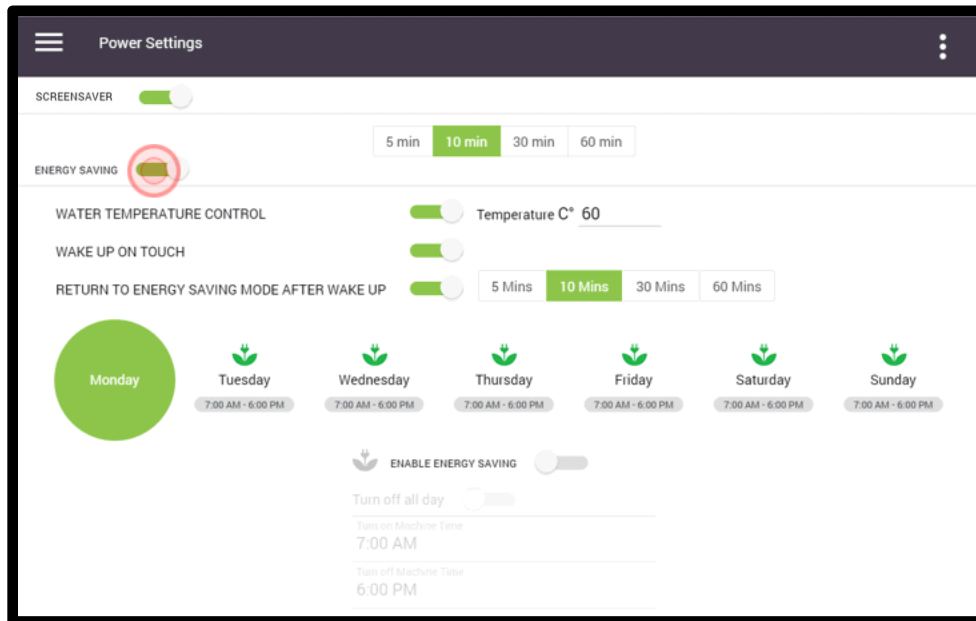

- a) **Water Temperature Control** - if enabled, the temperature at which the water in the tank is maintained while the machine is in 'Energy Saving' mode can be set here.
- b) **Wake Up on Touch** - the machine exits 'Energy Saving' mode when the screen is touched only if this option is activated.
- c) **Return to Energy Saving Mode After Wake Up** - if activated and set, it tells the machine when to go back into 'Energy Saving' mode after a wake up.

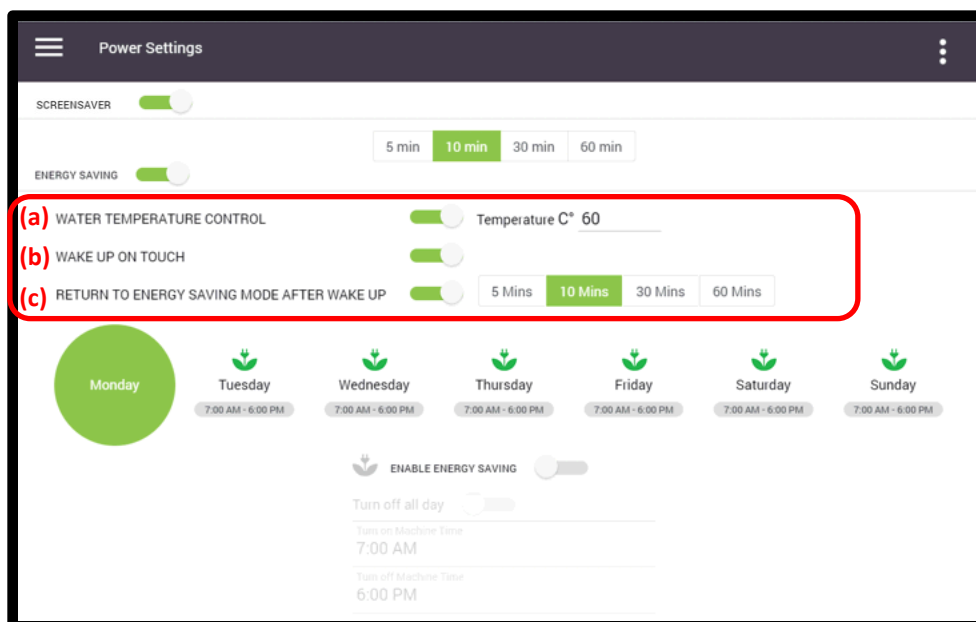

- Select the 'Day' for which you want to enable the Energy Saving mode (in this example, Monday is selected).

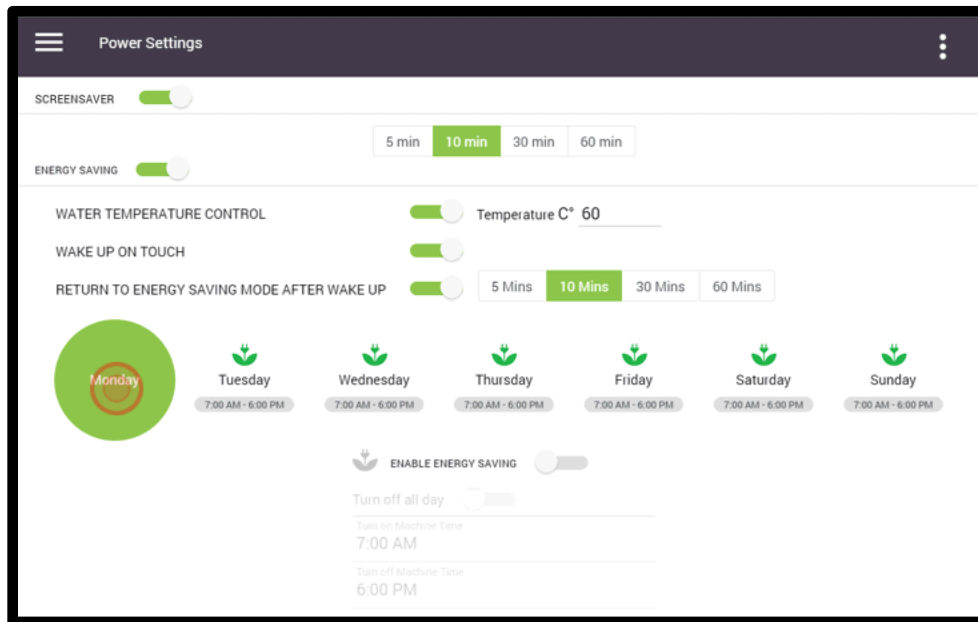

If using the Energy Saving mode, it must be activated and set individually for each day of the week.

- Tap the 'Enable Energy Saving' slider to enable the Energy Saving mode.

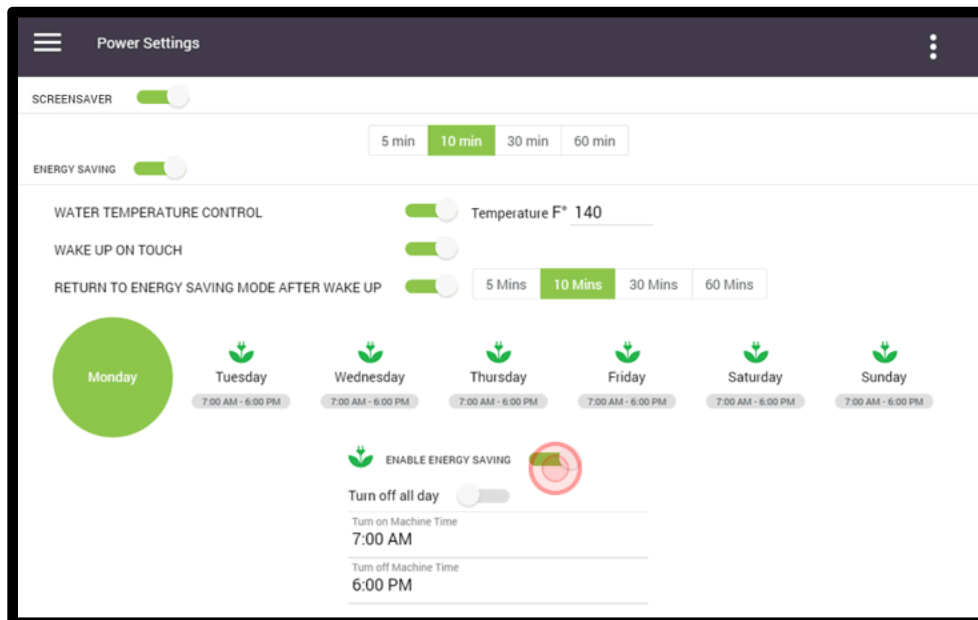

- To set the time that the machine turns ON (for Mondays in this example), tap on the 'Turn on machine time' setting.

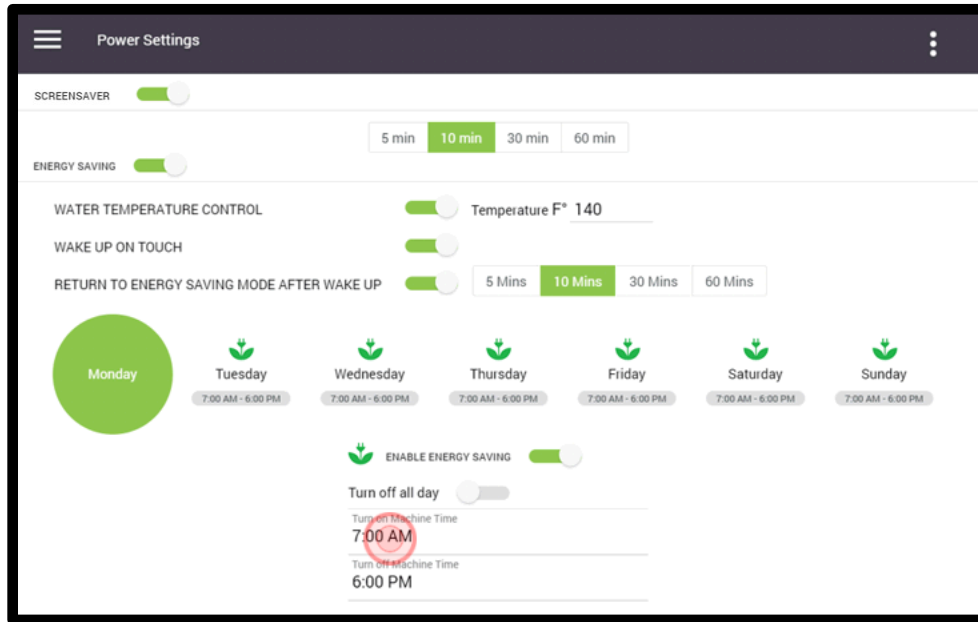

- Adjust each of the fields by scrolling up or down to the required setting. Once all are set, press 'Done' to save the time setting. The table in the image identifies what each of the fields of the scroll list represents.

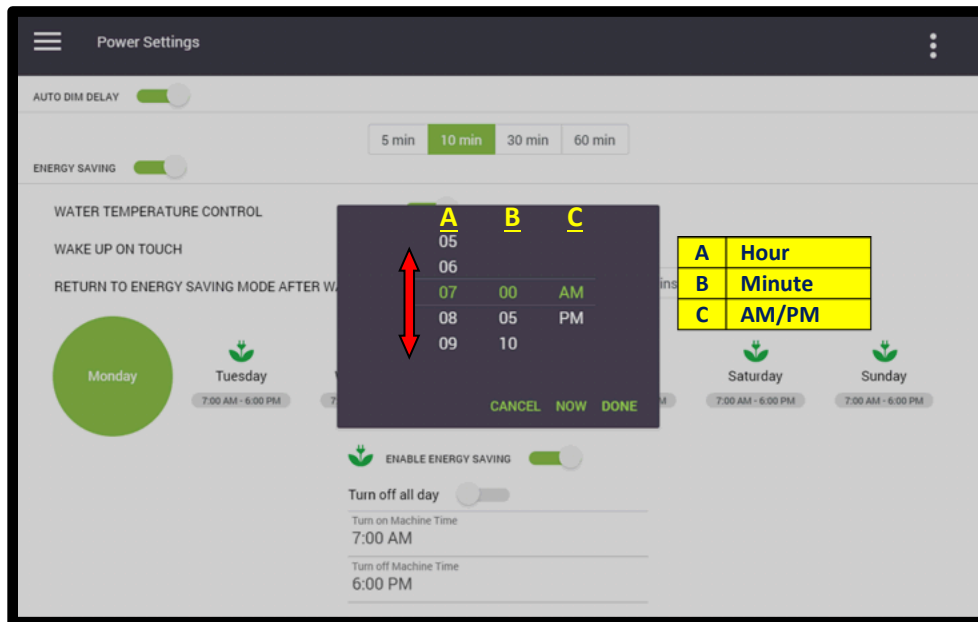

- Repeat this procedure for setting time that the machine turns OFF by tapping on the 'Turn off machine time' setting, and adjusting the time.

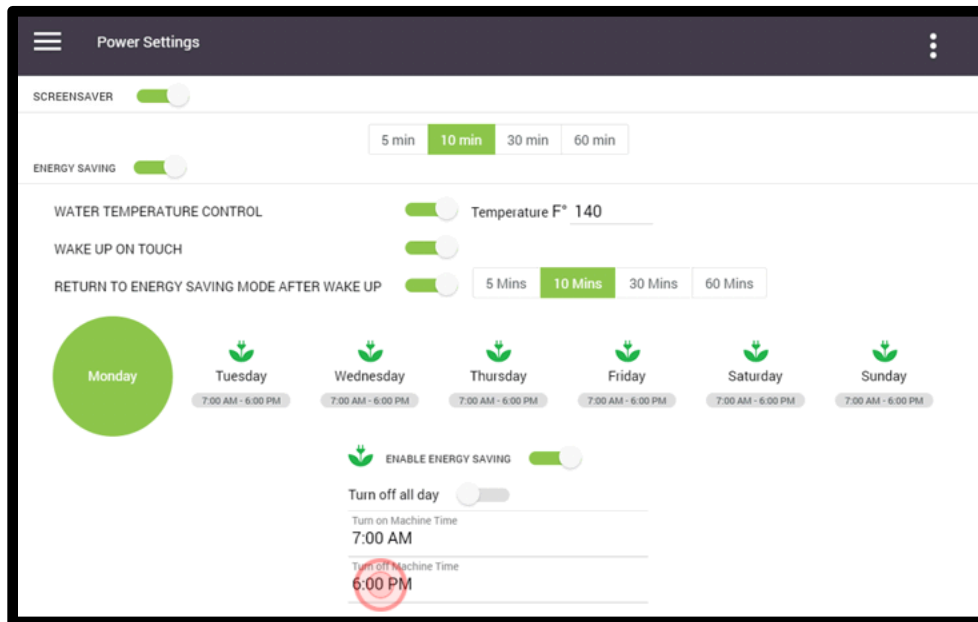

- Now that Monday is set, repeat the complete procedure to set the Energy Saving for every other day of the week.
- Should you need to set the machine to be in Energy Saving mode for the full day (on Sunday, for example), select the day and then enable the 'Turn off all day' option.

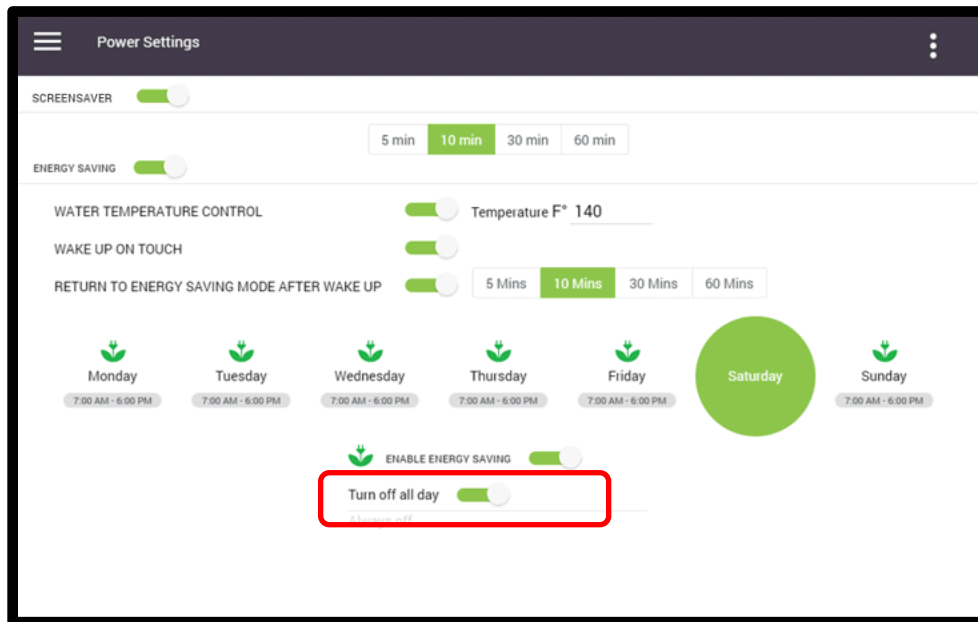

Vending (Cashless Pay)



The Momentum™ is currently only compatible with a Coin Changer unit or a Cashless option (card reader). **Consult the manufacturer documentation for configuring these devices.**

General Tab

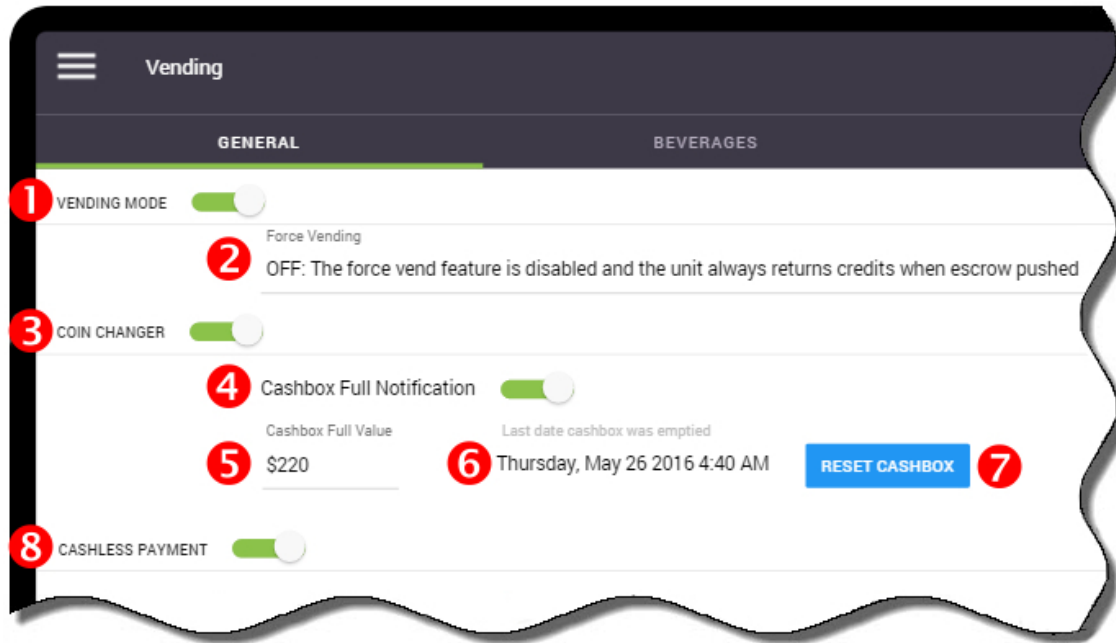

The **Vending Mode** slider **1** enables or disables the vending functions - vending is enabled when the slider is green.

You can also enable the '**Force Vending**' option **2**, which when enabled, prevents people from using the Momentum™ as a 'change maker'. This is usually done by inserting a \$1 or \$2 coin and then pressing the coin return button to have the machine dispense change in quarters. There are three possible configurations for this option:

- **OFF** - the force vend feature is disabled and the unit will function normally.
- **SMART** - the coin return feature of the changer is disabled when a \$1 or \$2 coin is inserted.
- **ON** - the coin return feature of the changer is completely disabled.

The vending devices are also enabled and disabled in this menu. The **Coin Changer** **3** and/or **Cashless (card reader)** **8** options and can be enabled in this menu.

The Cashbox options are configured in this menu. These include:

- **Cashbox Full Notification** **4** - a "Call for Service" message appears on the screen advising that the cashbox is full and requires emptying.
- The '**Cashbox Full Value**' **5** can be set here. This is the value used to determine when the Cashbox Full notification appears. By default, it is set to \$220. Tap on the value to change it, if required.
- The last date the cashbox was emptied (reset) can be verified here **6**.
- Tapping this button **7** resets the cashbox total counter.

Beverages Tab

The main page displayed in this tab shows a list of all of the available beverages and the pricing set for each. To change the price of a beverage, tap the "Edit Pricing" button and the screen will change to the pricing menu.

Recipe	Small			Medium			Large			Carafe		
	French Roast	Colombian	House Blend	French Roast	Colombian	House Blend	French Roast	Colombian	House Blend	French Roast	Colombian	House Blend
Coffee	\$1.00	\$1.00	\$1.00	\$1.00	\$1.00	\$1.00	\$1.00	\$1.00	\$1.00	\$1.00	\$1.00	\$1.00
Espresso	\$1.00	\$1.00	\$1.00	\$1.00	\$1.00	\$1.00	\$1.00	\$1.00	\$1.00	\$1.00	\$1.00	\$1.00
Cappuccino	\$1.00	\$1.00	\$1.00	\$1.00	\$1.00	\$1.00	\$1.00	\$1.00	\$1.00	\$1.00	\$1.00	\$1.00
Latte	\$1.00	\$1.00	\$1.00	\$1.00	\$1.00	\$1.00	\$1.00	\$1.00	\$1.00	\$1.00	\$1.00	\$1.00
Mocaccino	\$1.00	\$1.00	\$1.00	\$1.00	\$1.00	\$1.00	\$1.00	\$1.00	\$1.00	\$1.00	\$1.00	\$1.00
Mocha Coffee	\$1.00	\$1.00	\$1.00	\$1.00	\$1.00	\$1.00	\$1.00	\$1.00	\$1.00	\$1.00	\$1.00	\$1.00
Vanilla Coffee	\$1.00	\$1.00	\$1.00	\$1.00	\$1.00	\$1.00	\$1.00	\$1.00	\$1.00	\$1.00	\$1.00	\$1.00
Hot Chocolate		\$1.00			\$1.00			\$1.00			\$1.00	
Hot Milk Chocolate		\$1.00			\$1.00			\$1.00			\$1.00	
Vanilla		\$1.00			\$1.00			\$1.00			\$1.00	

Base Price Section

Beverage Type

Coffee

\$1.00

Size +

Small

\$0.00

Coffee Type +

French Roast

\$0.00

Base price = \$1.00

Exceptions

Coffee

\$1.00

Espresso

\$1.00

The pricing menu screen consists of 2 sections:

Base Price Section (Left Side): This section is where the beverage type, cup size and coffee type is selected and priced.

Exceptions (Right Side): This section allows you to create an exception and price a specific ingredient higher or lower than the base price.

Setting the Base Price

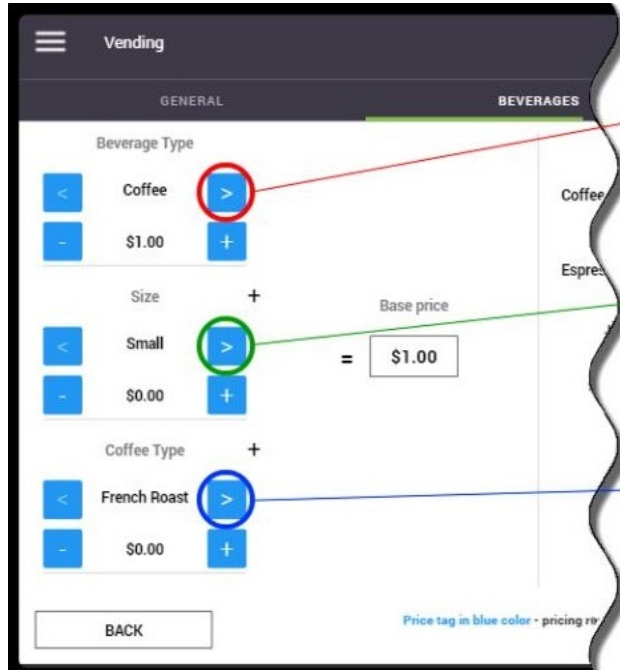

Beverage Type Selections

- Coffee
- Specialty
- Powders

Cup Size Selections

- Small
- Medium
- Large

Coffee Type Selections

- French Roast
- Colombian
- House Blend
- Decaf

1. Select the "**Beverage Type**" using the left/right arrows.
2. Set the "**Beverage Type**" price using the '+' or '-' buttons. The default price setting is \$1 for all selections. The base price of the product selected is shown in the "**Base Price**" box.

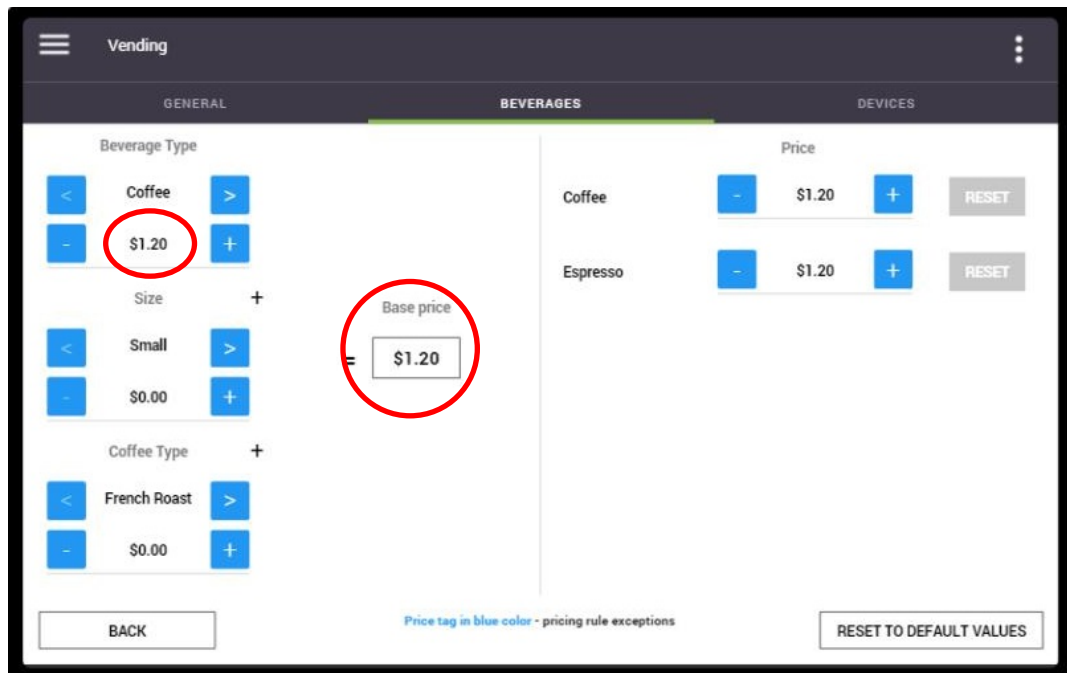

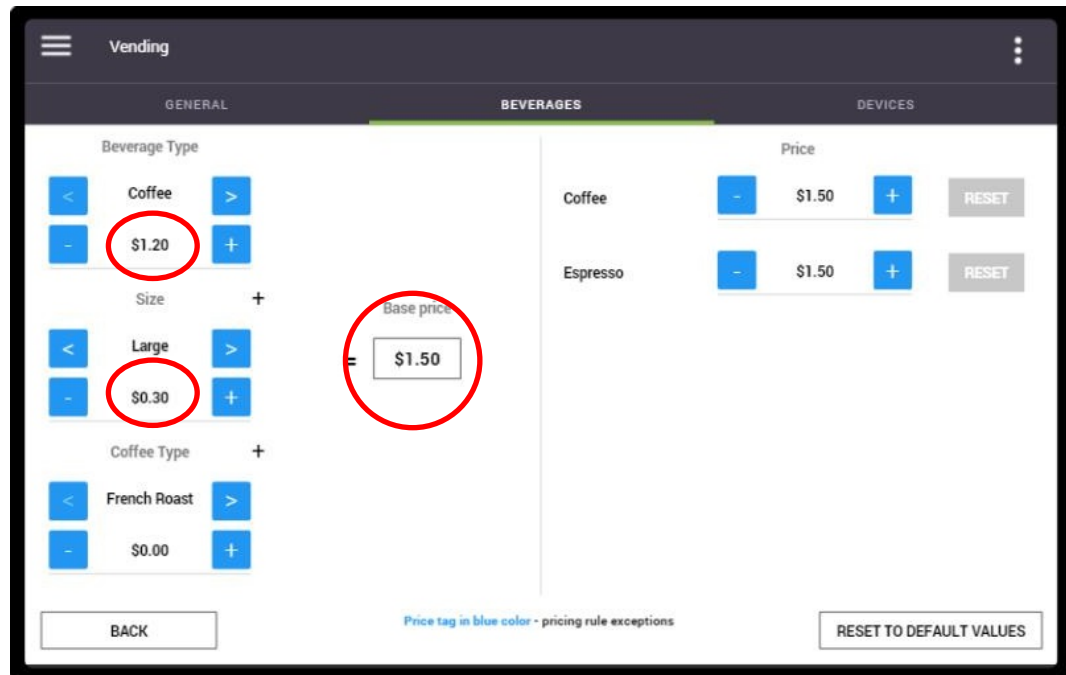

Please note that the options displayed may vary depending on the beverage type selected, but the method of pricing remains the same.

3. Select the **cup size** using the left/right arrows.
4. Increase the **cup size** price using '+' or '-' buttons. The price displayed here is added to the beverage type pricing. The **total** price of the product and cup size selected is shown in the "**Base Price**" box.

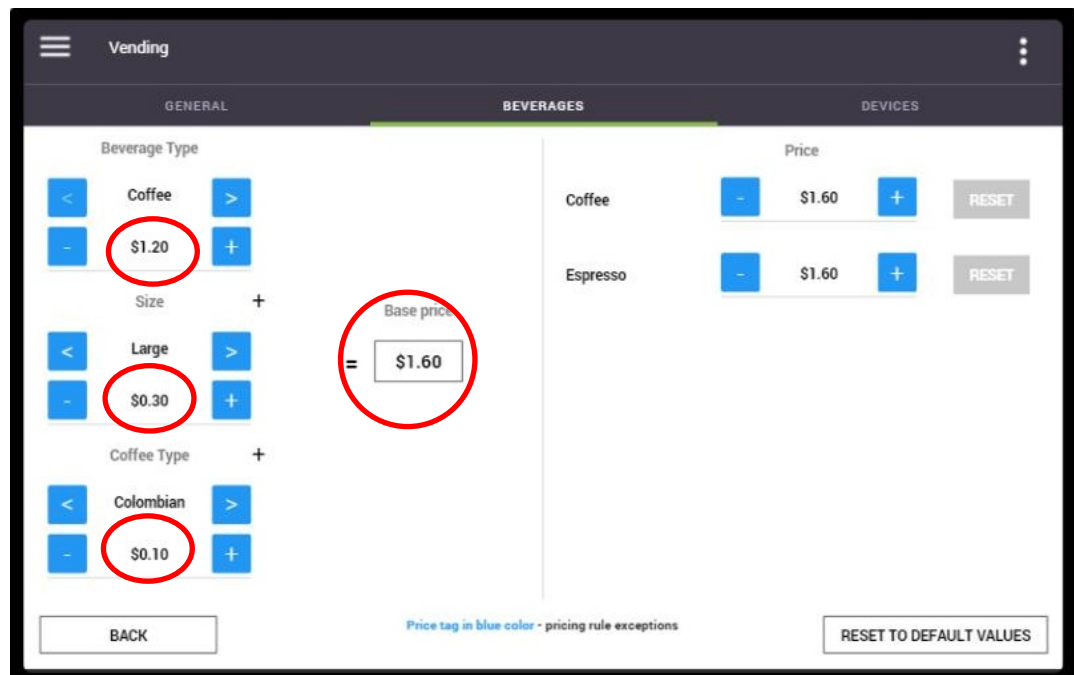

5. Should you want to set a different price for a specific coffee, select the "**Coffee Type**" using the left/right arrows.
6. Increase the "**Coffee Type**" price using '+' or '-' buttons. The price displayed here is added to the beverage type and cup size pricing. The **total** price of the product, cup size and coffee type selected is shown in the "**Base Price**" box.



Adjusting the Price for Exceptions

This section allows you to create an exception and price a specific ingredient higher or lower than the base price. The images below show the available "Exception" pricing options, based on the type of beverage that is selected in the left section.



Using the "Coffee" selection as an example, if you want to make a pricing exception for the 'Espresso' and sell it for 15 cents more than the regular coffee, you can increase **only the Espresso price** by using '+' button beside it. Note that pricing exceptions are identified in blue.

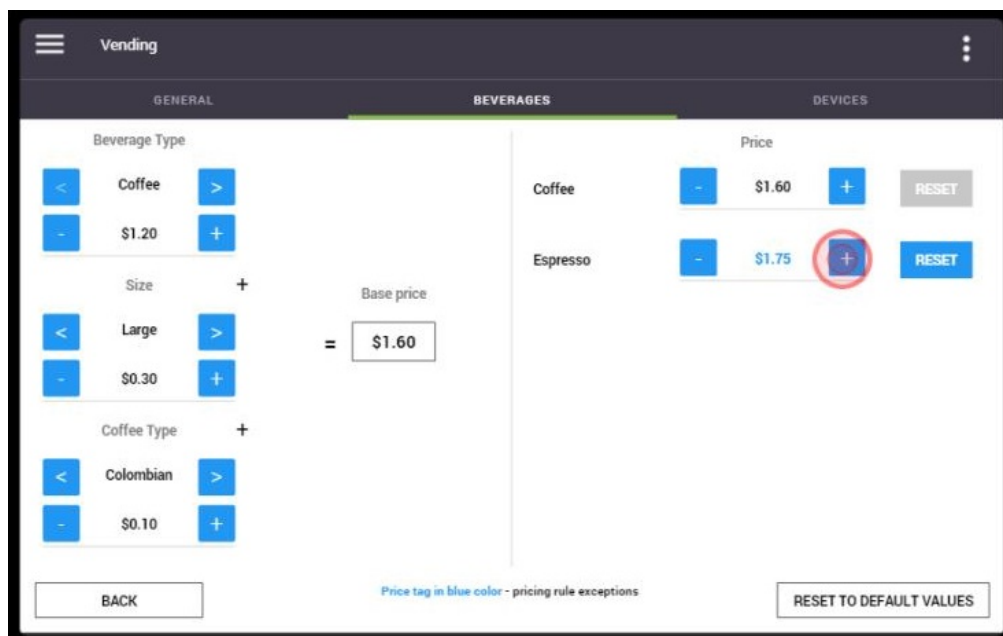

If you go back to the main screen of the Beverages tab, you can see the pricing changes that were made. The prices in blue indicate pricing exceptions.

Recipe	Small				Medium				Large				Carafe			
	French Roast	Colombian	House Blend	Decaf	French Roast	Colombian	House Blend	Decaf	French Roast	Colombian	House Blend	Decaf	French Roast	Colombian	House Blend	Decaf
Coffee	\$1.00	\$1.00	\$1.00	\$1.00	\$1.00	\$1.00	\$1.00	\$1.00	\$1.60	\$1.60	\$1.60	\$1.60	\$1.00	\$1.00	\$1.00	\$1.00
Espresso	\$1.00	\$1.00	\$1.00	\$1.00	\$1.00	\$1.00	\$1.00	\$1.00	\$1.00	\$1.75	\$1.00	\$1.00	\$1.00	\$1.00	\$1.00	\$1.00
Cappuccino	\$1.00	\$1.00	\$1.00	\$1.00	\$1.00	\$1.00	\$1.00	\$1.00	\$1.00	\$1.00	\$1.00	\$1.00	\$1.00	\$1.00	\$1.00	\$1.00
Latte	\$1.00	\$1.00	\$1.00	\$1.00	\$1.00	\$1.00	\$1.00	\$1.00	\$1.00	\$1.00	\$1.00	\$1.00	\$1.00	\$1.00	\$1.00	\$1.00
Mocaccino	\$1.00	\$1.00	\$1.00	\$1.00	\$1.00	\$1.00	\$1.00	\$1.00	\$1.00	\$1.00	\$1.00	\$1.00	\$1.00	\$1.00	\$1.00	\$1.00
Mocha Coffee	\$1.00	\$1.00	\$1.00	\$1.00	\$1.00	\$1.00	\$1.00	\$1.00	\$1.00	\$1.00	\$1.00	\$1.00	\$1.00	\$1.00	\$1.00	\$1.00
Vanilla Coffee	\$1.00	\$1.00	\$1.00	\$1.00	\$1.00	\$1.00	\$1.00	\$1.00	\$1.00	\$1.00	\$1.00	\$1.00	\$1.00	\$1.00	\$1.00	\$1.00
Hot Chocolate	\$1.00				\$1.00				\$1.00				\$1.00			
Hot Milk Chocolate	\$1.00				\$1.00				\$1.00				\$1.00			
Vanilla	\$1.00				\$1.00				\$1.00				\$1.00			

Price tag in blue color - pricing rule exceptions

To change the pricing for other beverages that are listed, tap the "Edit Pricing" option. To reset the "Exception" pricing (in blue) to its default value, tap the "Reset to Default Values" option.

Pricing Hot Water

If you would like to add a price for "Hot Water", you need to disable the "Press&Hold" setting for Hot Water. This is done in the "Recipes" tab of the Setup menu ([page 78](#)).

Devices Tab

This tab provides detailed information about the vending devices connected to the Eccellenza Touch (if this information is available on the device).

GENERAL	PRICING	DEVICES
Coin Changer Max MDB level supported: 3 Manufacturer: MAK Serial number: 152529968 Model #/Tuning revision: Unknown Software version: 15 Optional features: Alternative payout method Tube configuration: Tube A: \$0.05 Tube G: \$2.55 Tube M: \$0.00 Tube B: \$0.10 Tube H: \$0.00 Tube N: \$0.00 Tube C: \$0.25 Tube I: \$0.00 Tube O: \$0.00 Tube D: \$1.00 Tube J: \$0.00 Tube P: \$0.00 Tube E: \$2.00 Tube K: \$0.00 Tube F: \$2.55 Tube L: \$0.00		Cashless Device Max MDB level supported: Unknown Manufacturer: Unknown Serial number: Unknown Model #/Tuning revision: Unknown Software version: Unknown Optional features: Unknown

Network

The Network screen is used to configure the network connection and SMTP settings, as well as notification settings that allow the Momentum™ to send email notifications concerning consumption, sales and faults/messages.

WIFI

Should you want to establish remote communication with the Momentum™, you'll first need to enable the WiFi feature by tapping on the '**WiFi Connexion**' slider.

1. Once WiFi is enabled, the Momentum™ begins scanning for any wireless networks in its vicinity.

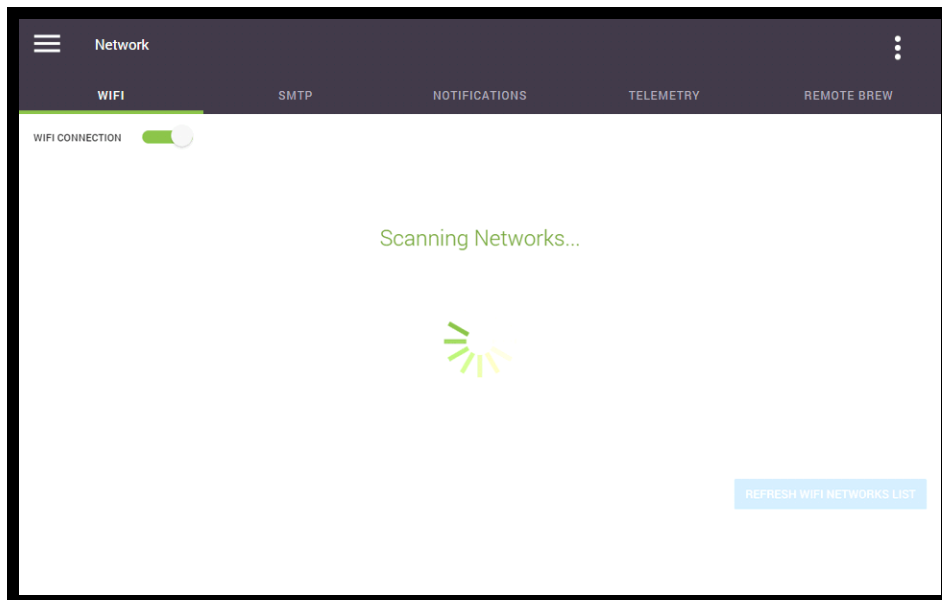

2. When scanning is complete, all of the detected networks are listed on the screen.

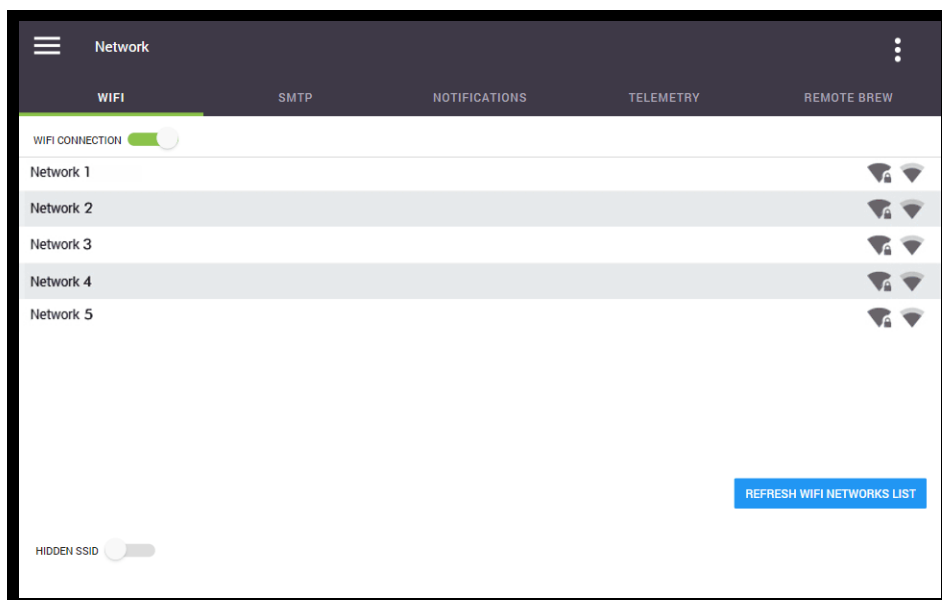



You will be required to work with the customer's IT administrator to obtain their WiFi login credentials (Network Name/SSID and Network Password), as well as any required network permissions. Without these credentials, it is not possible to connect to a network to use the machine's WiFi capabilities.

3. Select the network to which you want the Momentum™ to connect, and then tap on the 'Connect' button.

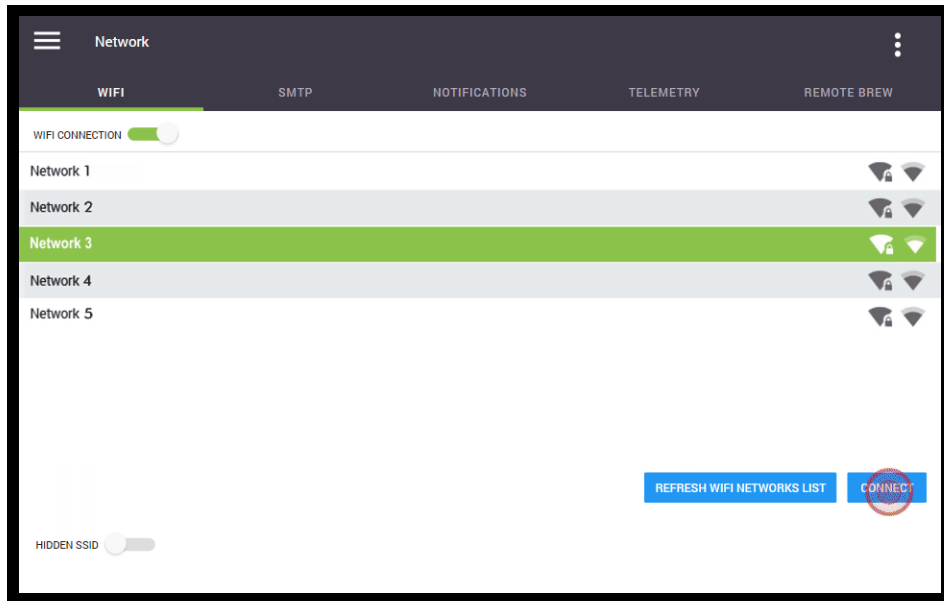

4. The keyboard appears and you must now type in the required password to connect to the selected network. Once done, tap the 'Accept Change' button.

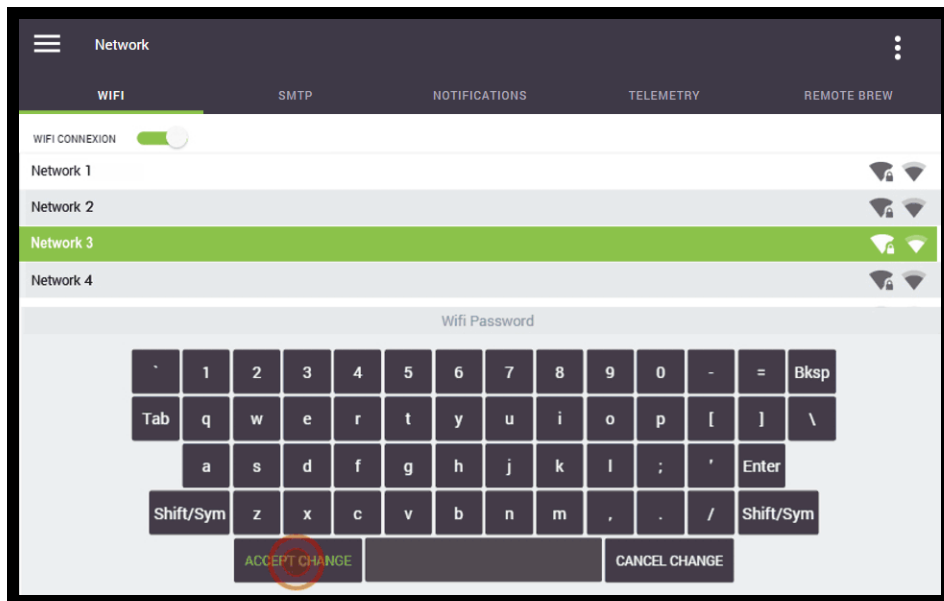

5. The Momentum™ now communicates with the network server and if the correct credentials were used, network access is granted. Once connected to the network, a green indicator appears to the right of the network name/SSID

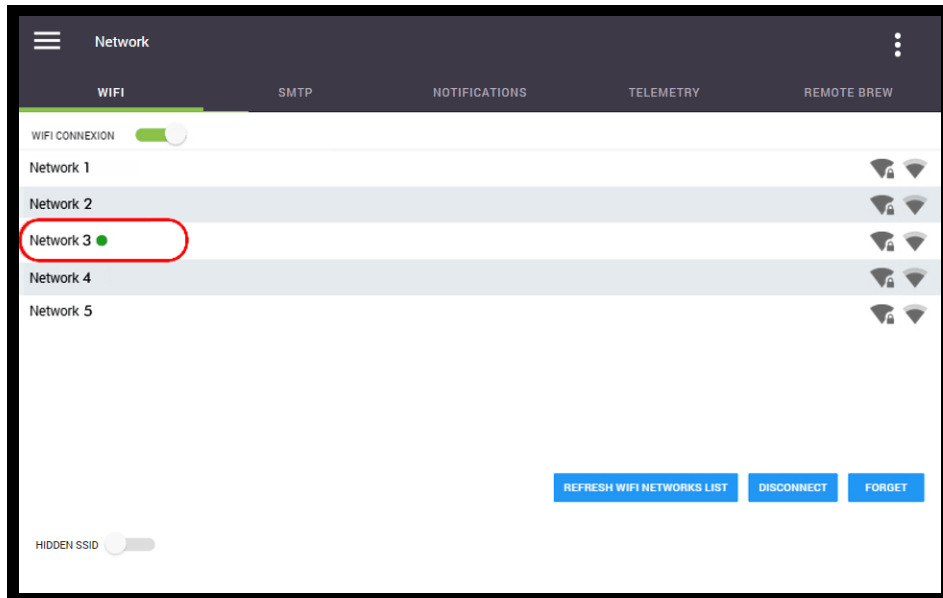

Telemetry and WiFi cannot be enabled at the same time – you must select one or the other, after rebooting the machine.

Hidden SSID

If the SSID is hidden, touch the 'Hidden SSID' slider and enter the necessary credentials.

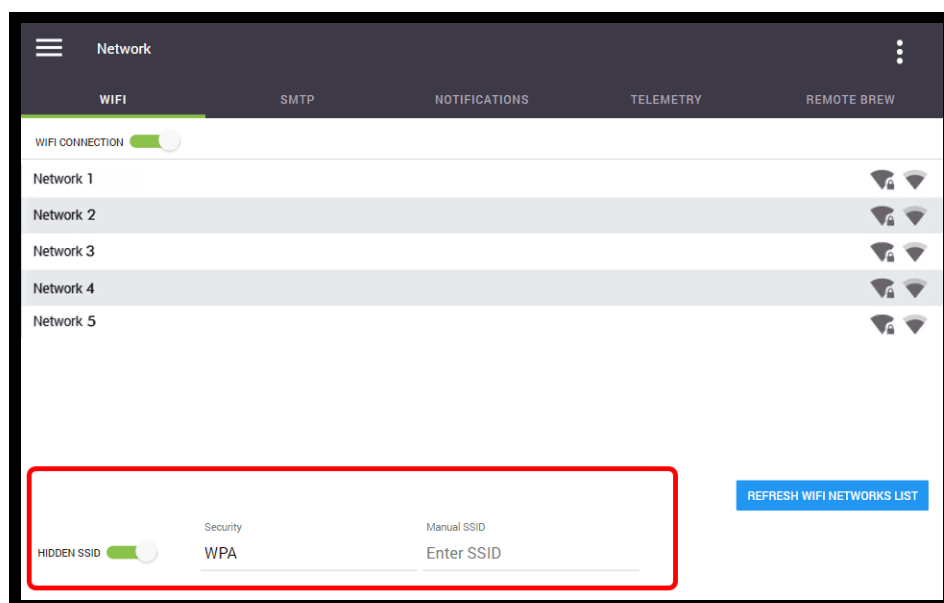

SMTP



To use the SMTP capabilities of the Momentum™, you need to have **both** a network connection **and** a dedicated SMTP server. Contact your company's or your customer's IT Department for more information about setting up an SMTP server. It may also be possible to use an online SMTP server provider, such as Gmail or Yahoo (see [page 61](#) for details).

Only after obtaining network access, the Momentum™ can then be configured to upload notifications concerning consumption, sales and faults/messages directly to your SMTP server.

1. Tap on the 'Requires Authentication' slider to activate the SMTP feature.

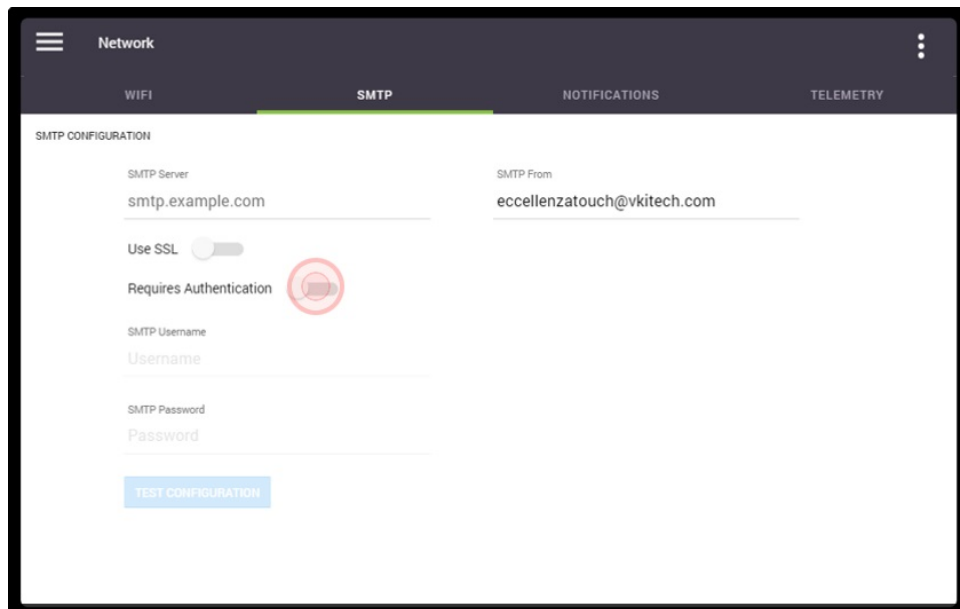

2. Enter the required information in the SMTP Server field, as well as your SMTP username and password, and then tap the 'Test Configuration' button to validate that your configuration is functioning properly.

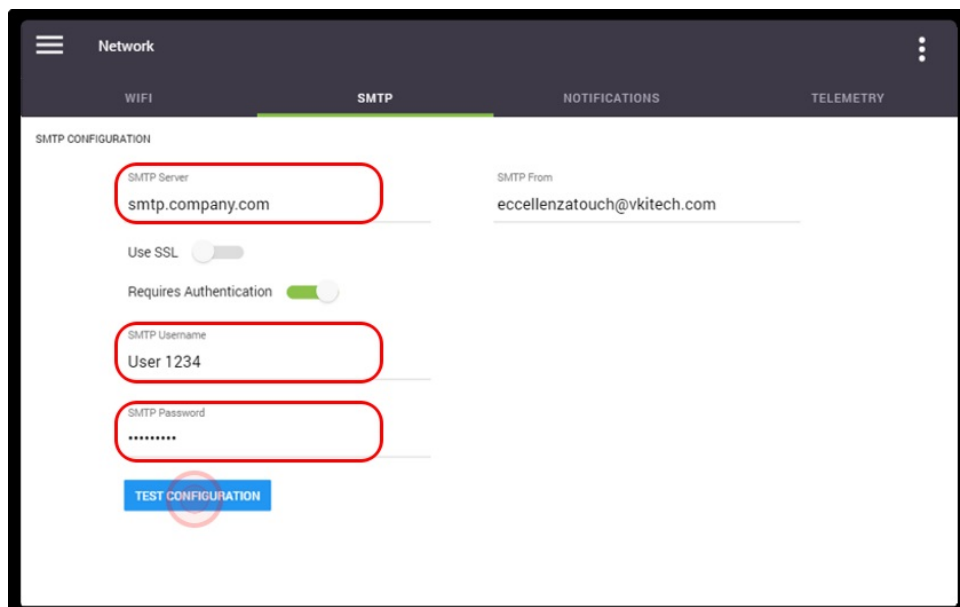

Online SMTP Server Providers

If an SMTP server is not available through your IT Department or through your customer's IT Department, you may want to try using a public online SMTP server provider.

The following are just a few of the SMTP servers available online:

- **smtp.gmail.com:587** – Use SSL = YES, Request Authentication = YES
- **smtp.mail.yahoo.com:587** – Use SSL = YES, Request Authentication = YES
- **smtp-mail.outlook.com:587** – Use SSL = YES, Request Authentication = YES



Note that it is necessary to create an account with the provider you wish to use. Also note that the provider may impose limits and certain conditions.

Notifications

The **'Notifications'** screen is used to configure the Momentum™ to send notifications concerning ingredient consumption, beverage sales, counters and faults/messages directly into your email's Inbox. Fault and message notifications are sent immediately after they occur so that they can be addressed as soon as possible to minimize downtime. Consumption, sales and counter notifications can be set to be sent on a daily (**at midnight**), weekly or monthly basis.



An SMTP server must first be configured to be able to use the 'Notifications' feature ([see page 60](#)).

1. Tap on the **'Email Notifications'** slider to activate this feature, and then t.

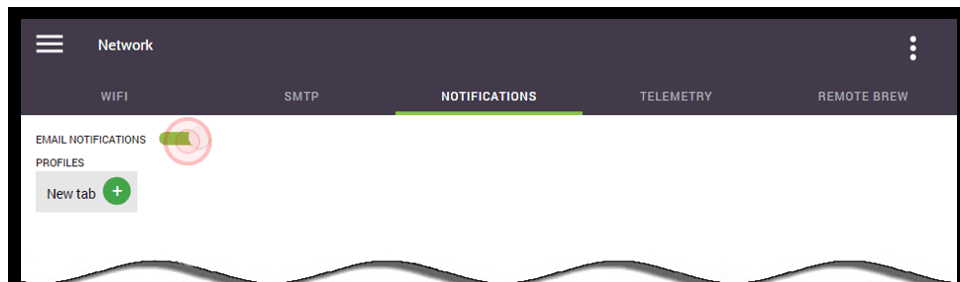

2. Tap on the **'New Tab'** and then **'Enter Email Address'** field to bring up the keyboard.

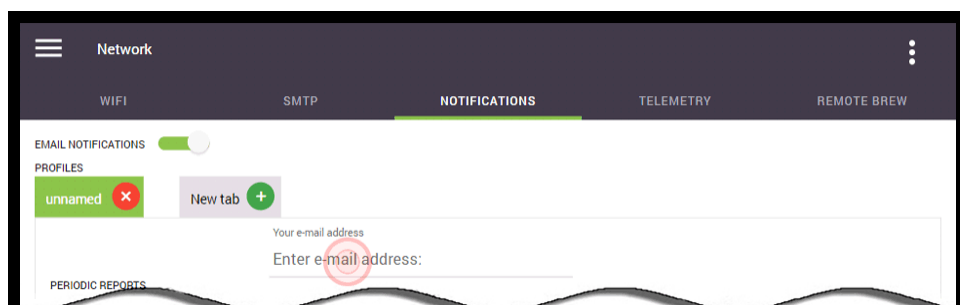

3. Type the email address to which the notifications will be sent, and press 'Accept Change'.

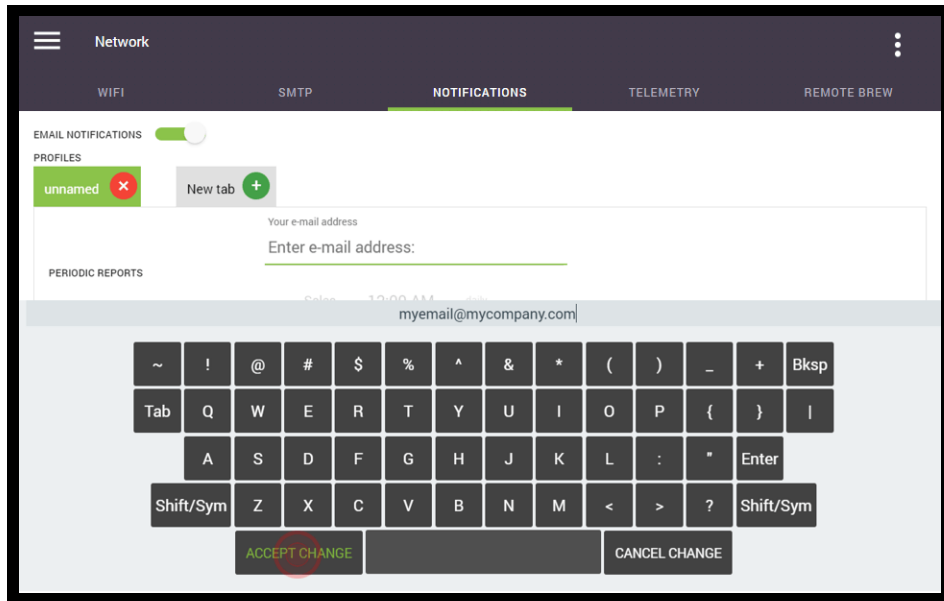

4. Set the time at which each type of notification is to be sent by tapping the respective time field and adjusting it accordingly.

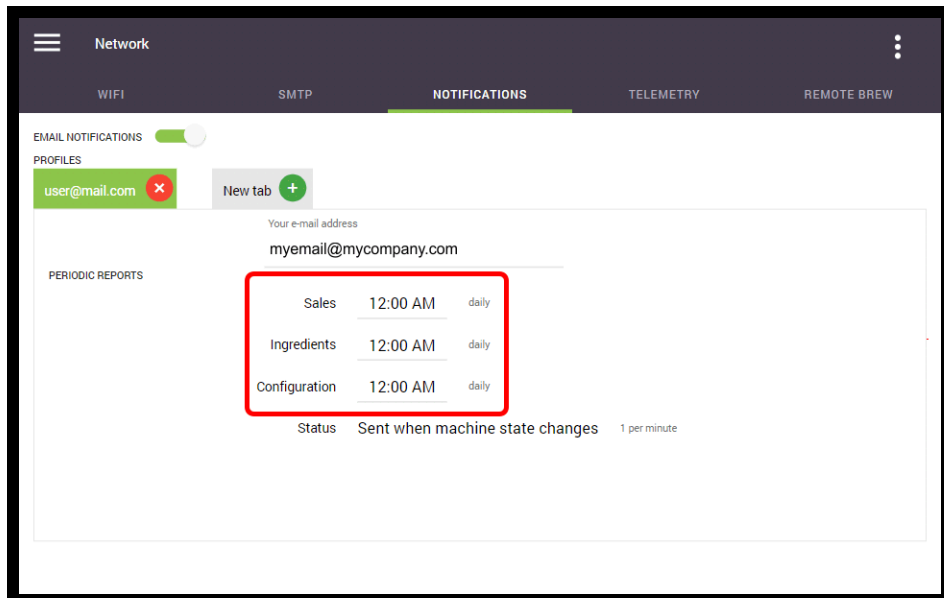

The following are some examples of the types of reports that are sent to the email address(es) entered:

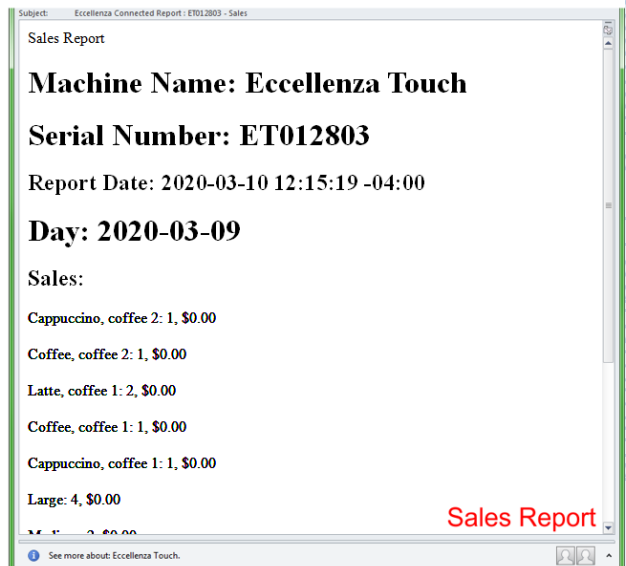
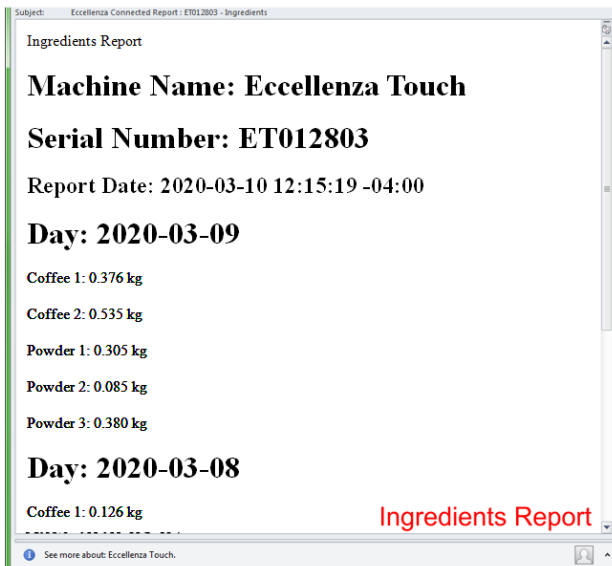
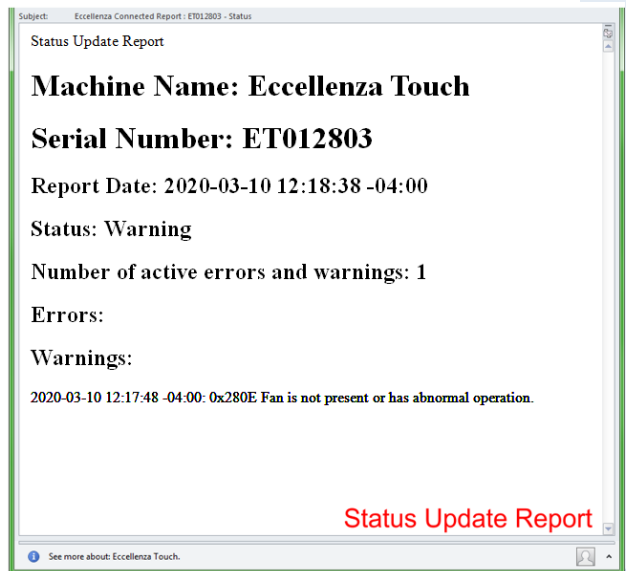
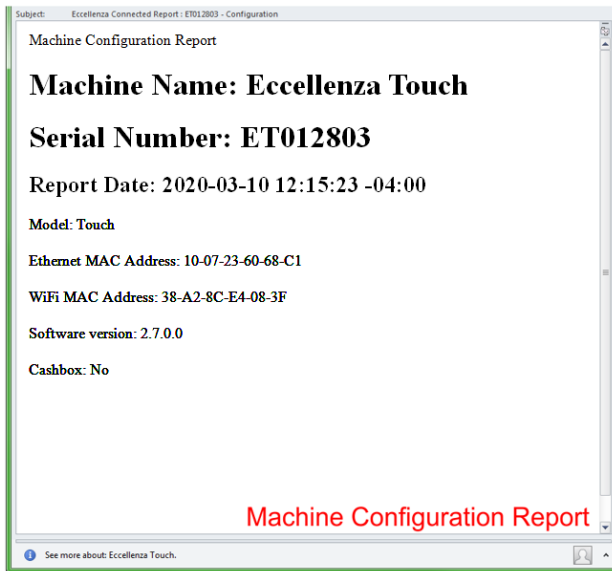

Telemetry

The 'Telemetry' option (if activated) provides an essential link between your machine and the online Eccellenza Connected Telemetry Management System via cellular network. It allows you to monitor real-time sales and consumption for your VKI equipment using your computer Browser, without having to be on-site.

Please note that the Telemetry feature on the Eccellenza Momentum™ only works if you have subscribed to VKI's Telemetry Management System. Please contact VKI Customer Service for pricing and details.

To configure the Telemetry feature, go to the "Network" section of the programming, select the "Telemetry" tab, and enable the "Telemetry" option.

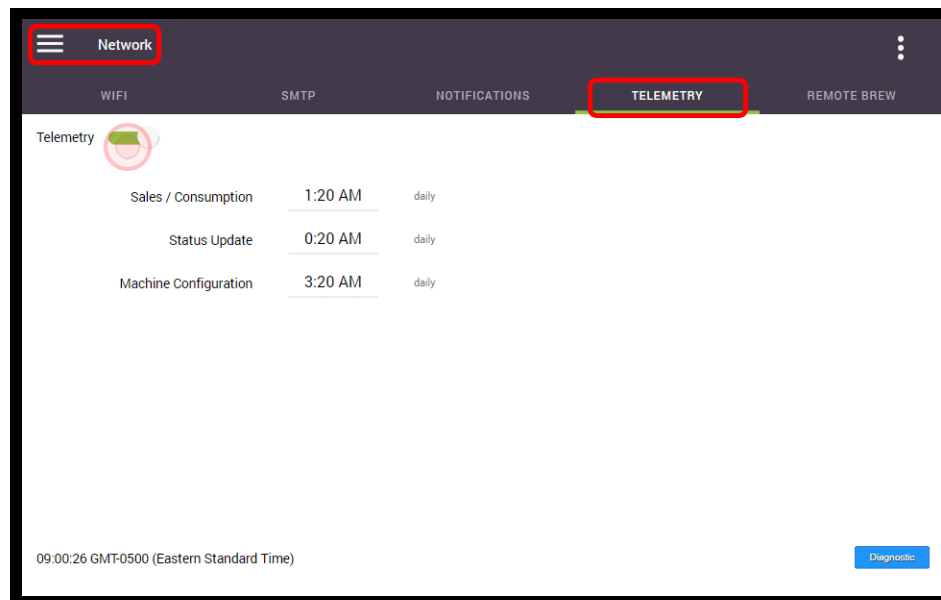

Please note that once telemetry is enabled, it may take a few minutes for communication to be established with the cellular network.

Just like the email notifications, you can also set the times of day at which the three types of data are transmitted to your Eccellenza Connected dashboard.



Telemetry and WiFi cannot be enabled at the same time – you must select one or the other, after rebooting the machine.

Setup

The Setup screen is used to configure and rename products and beverages, set recipes and timings, set temperature, and perform product calibrations.

Hoppers

The Hoppers tab allows you to disable/enable (with a simple touch) any of the three coffee bean dispensers if that particular blend is not used. If a coffee blend is disabled, the hopper color changes from green to red (decaf, in the example below), and that coffee type no longer appears on any of the beverages on the main selection screen.

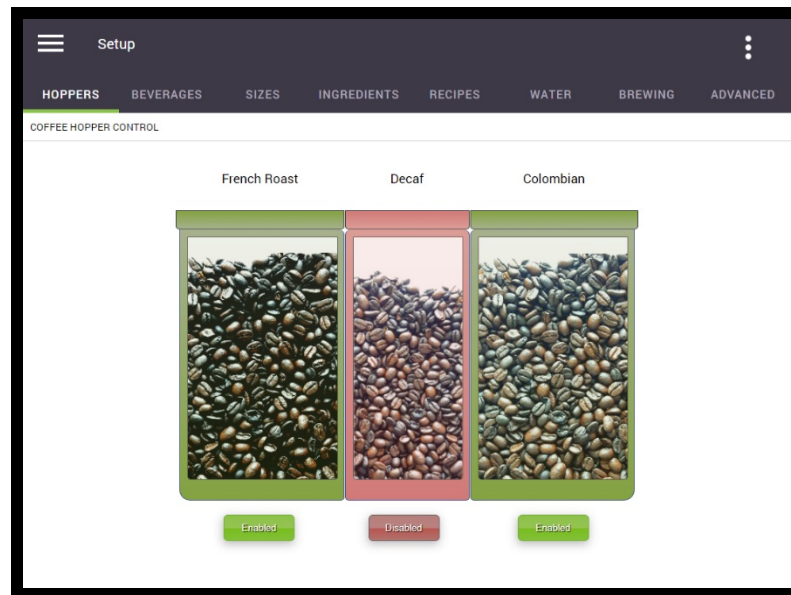

Beverages

Setting Cup Strength

The coffee strengths can be adjusted on the main screen of the 'Beverages' menu. In the example below, all three coffee strengths are enabled (green).

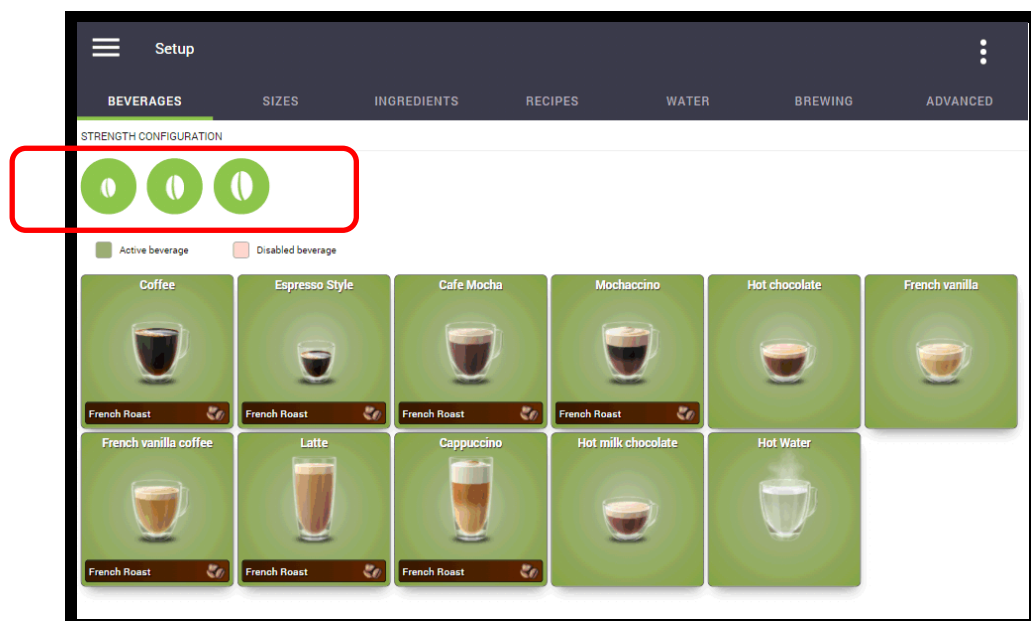

If, for example, you want to offer only medium strength, simply tap on the mild and strong strengths to disable them.

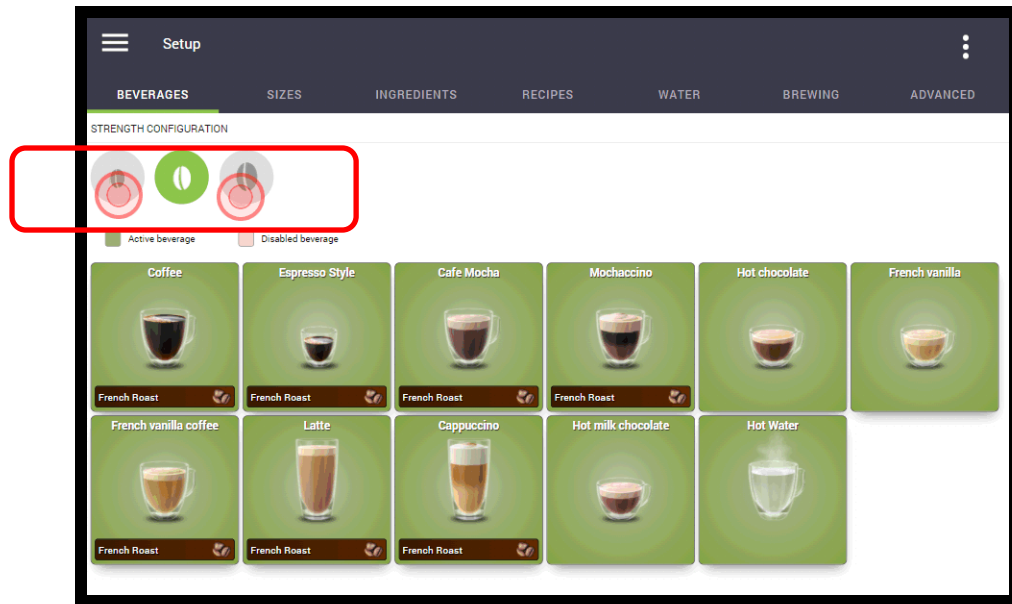

Setting the Default Coffee Blend

While in the 'Beverages' tab, you can set the default coffee type to be used for each beverage that uses coffee. By default, they are all set to “French Roast”, as you can see in the image below.

The default coffee **must be set for each of the beverages independently**, as there is no global setting for this option. To change the default coffee blend, tap the blend shown beneath the beverage to cycle it to the next blend. Repeat the process until the required blend is displayed.

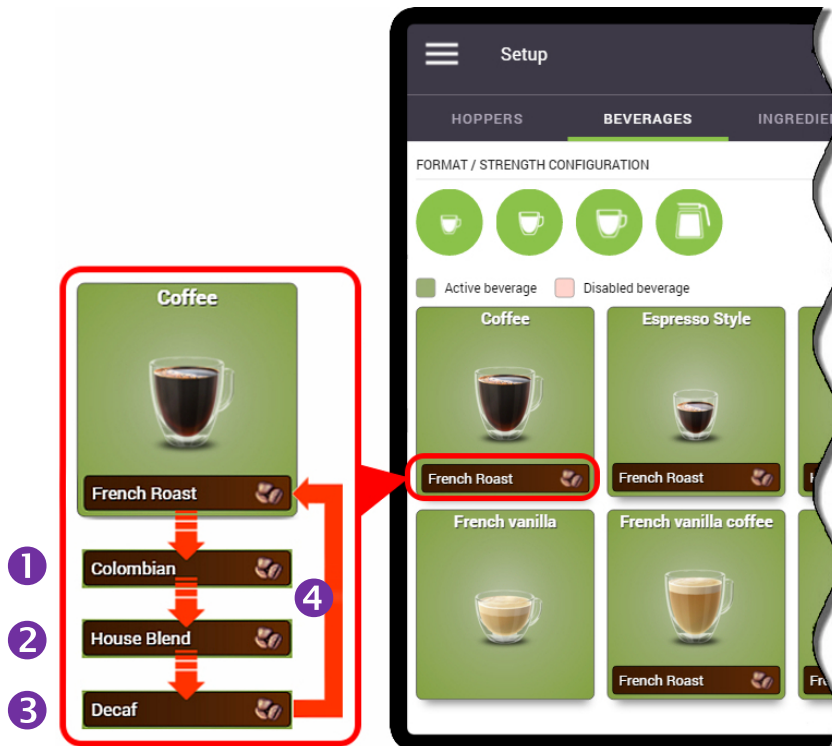

Repeat this procedure for any of the other beverage, if necessary.

Disabling Beverages

While in the **'Beverages'** tab, you can also disable one or multiple beverages, if required. To disable a beverage, simply touch the image of the beverage on the screen, and the image background changes to **red**, indicating that the beverage is disabled. To re-enable the beverage, touch it once more – the background changes to green.

In the example below, the **Hot Chocolate** beverage is red, indicating that it has been disabled.

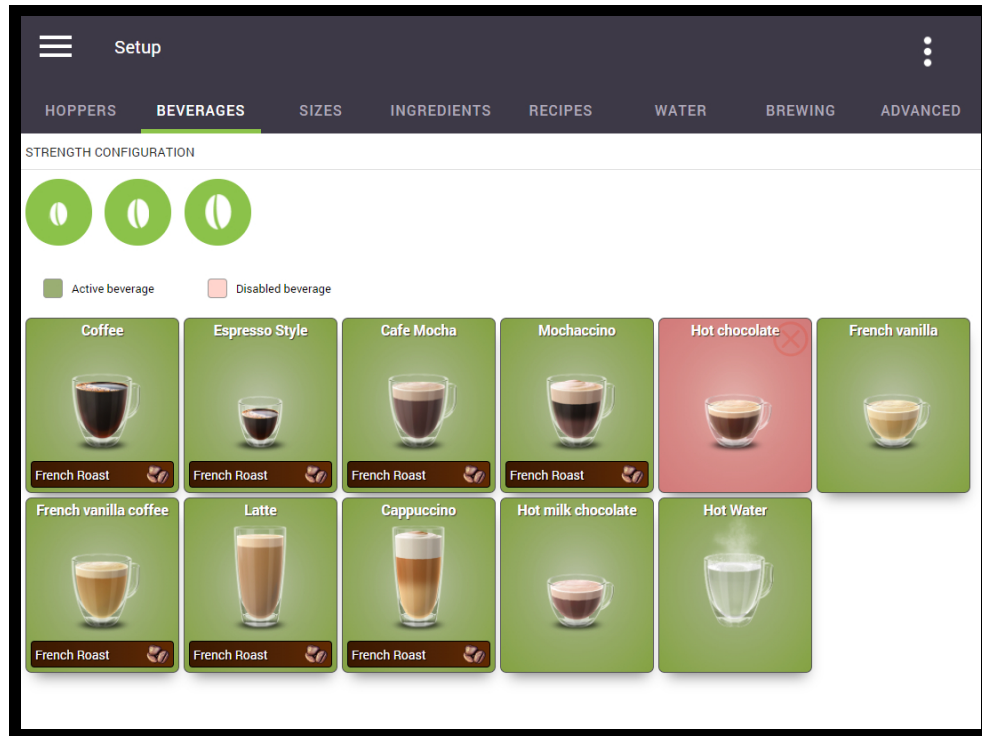

The disabled product will no longer be offered on the main screen.

Configuring Cup Sizes

Select the “Sizes” tab if you want to change the default cup size, select a pre-set cup size label, or customize the cup size label for a specific beverage or for multiple beverages.

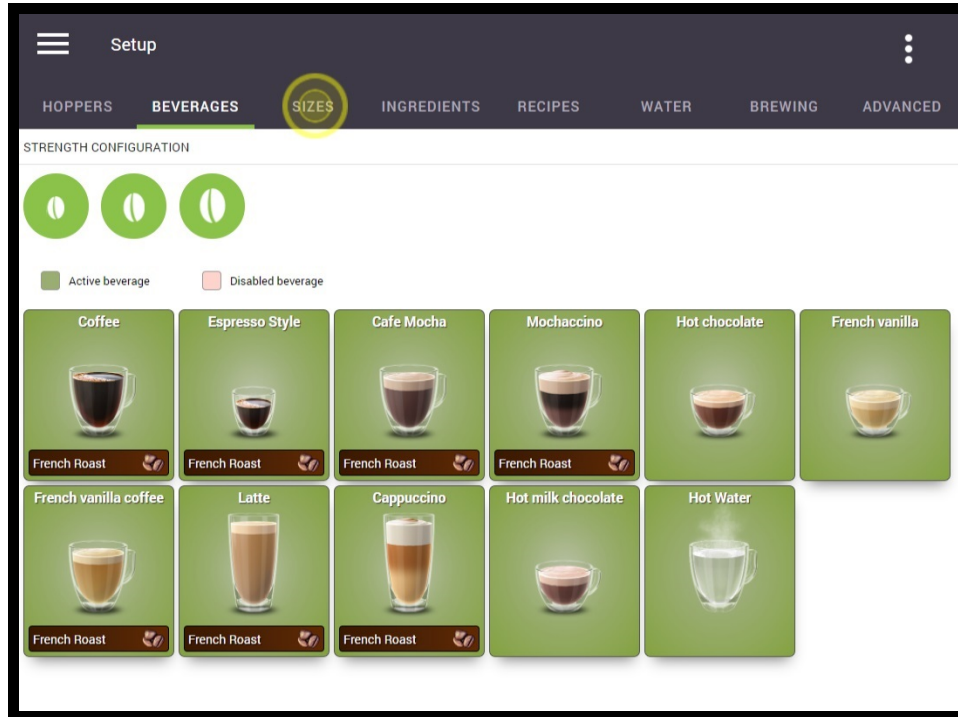

Setting the Default Cup Size

The Medium cup size is the pre-set default cup size. If you want to set one of the other cups as the default cup size, simply tap the “Make Default” option under the required cup size. Note that it is possible to default to the Carafe option, if needed.

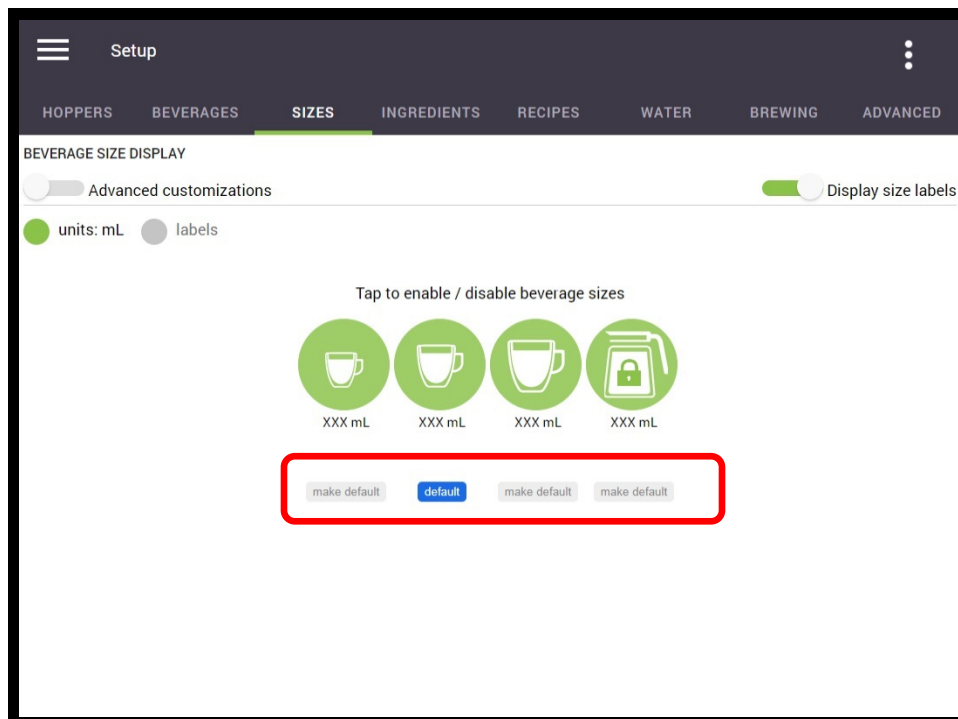

Selecting and Customizing Cup Size Labels

If the “Units” option is selected, the cup size labels will display the cup size volume, either in millilitres or by ounces, depending on the units setting in the ‘Regional’ tab under the ‘General Settings’ menu.

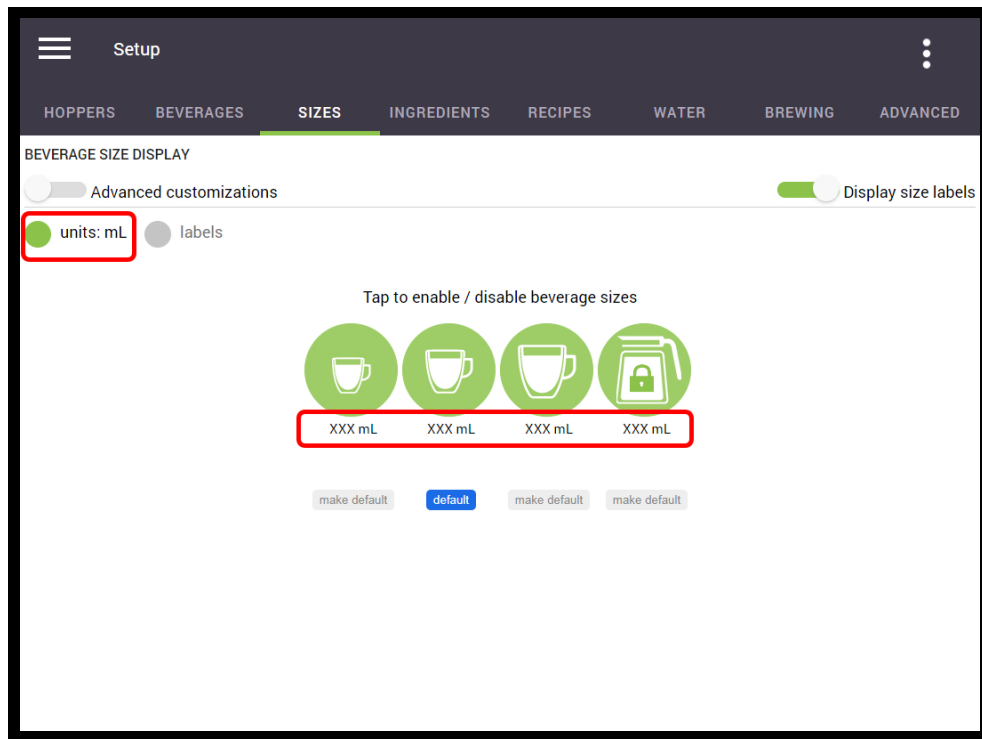

If the “Labels” option is selected, the cup size labels will display the pre-set cup size labels (Small, Medium, Large, Carafe).

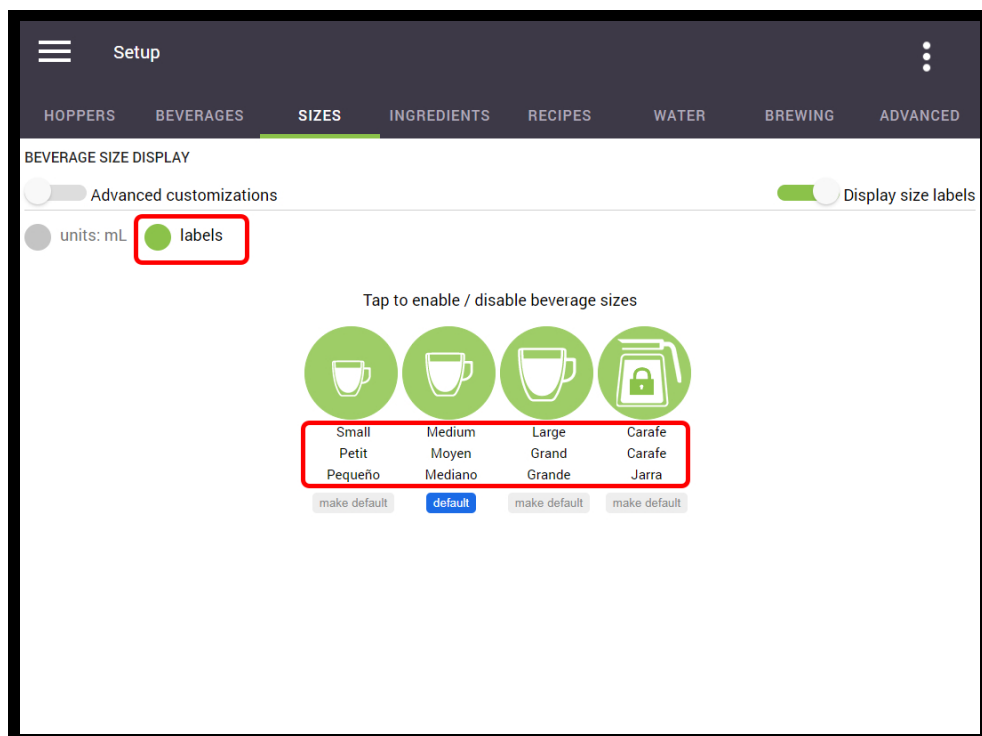

To customize the cup size labels, touch to activate the “Advanced Customizations” slider.

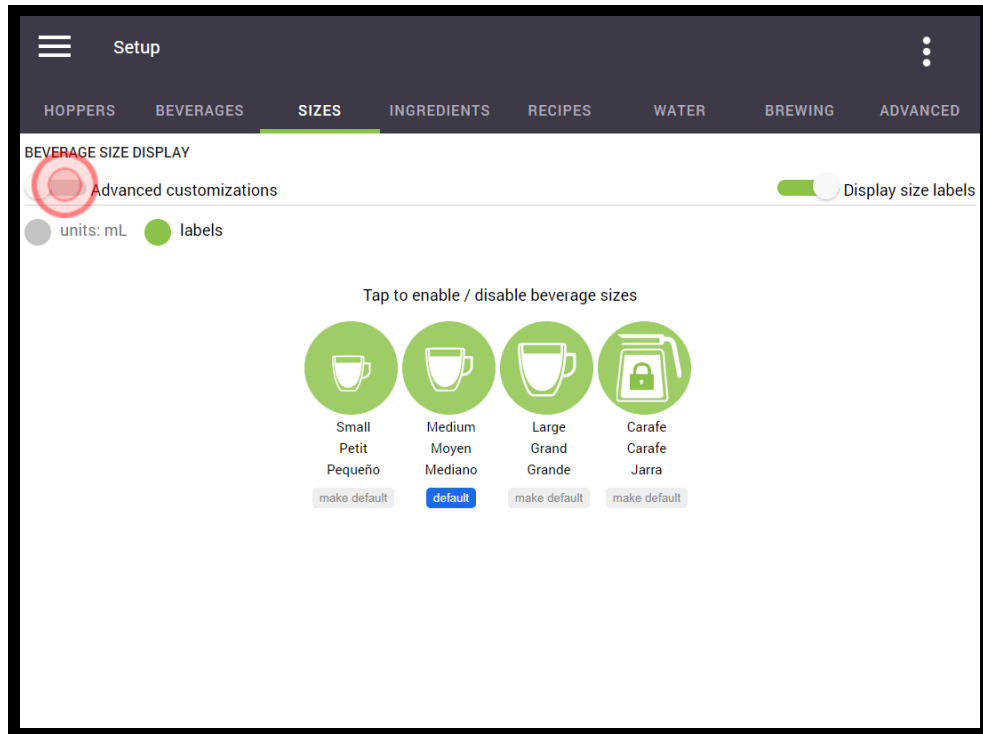

1. Select the beverage whose label you would like to customize.

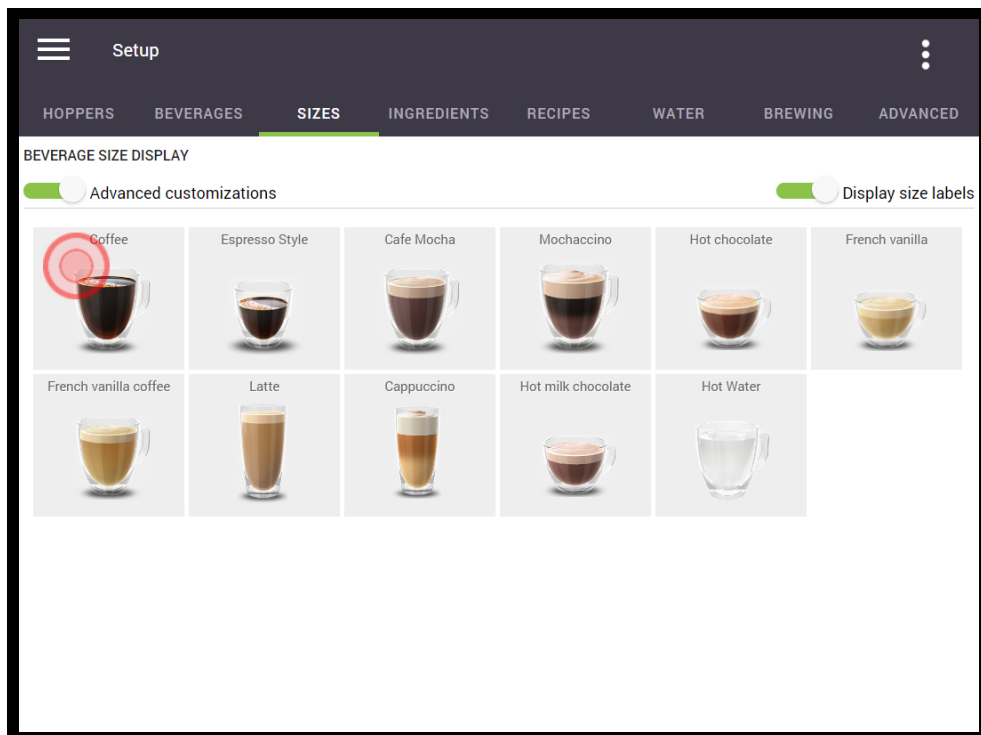

 **Note that any changes made to this beverage can then be applied to multiple beverages at the end of this procedure.**

- Select the existing label that you want to customize (cup size and language).

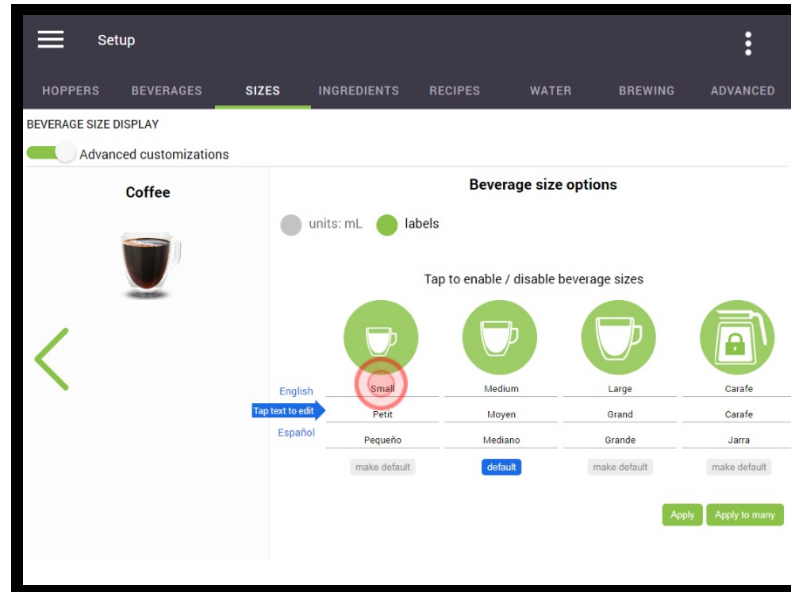

Note that you will need to manually customize the cup size label for each language being used. It will not change automatically.

- Using the keyboard, change the name of the cup size label and then press “Accept Change”. In this example, “Small” is being changed to “Regular”.

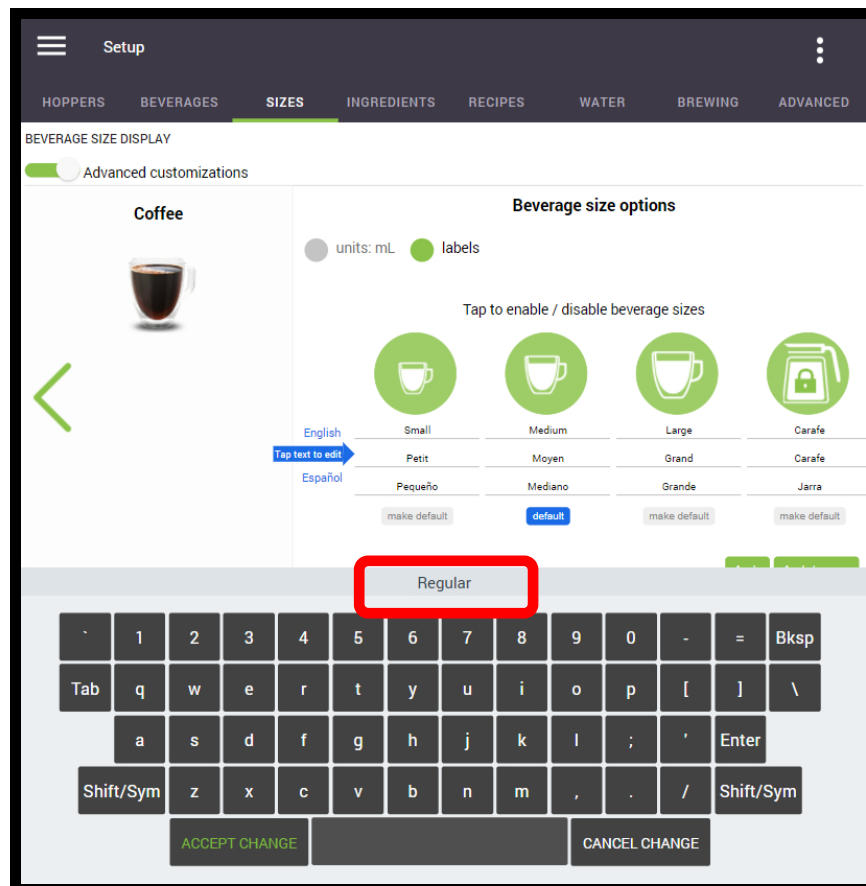

- The changes made will now be visible on the main label screen. Tap on **“Apply”** to apply this change to this particular beverage.

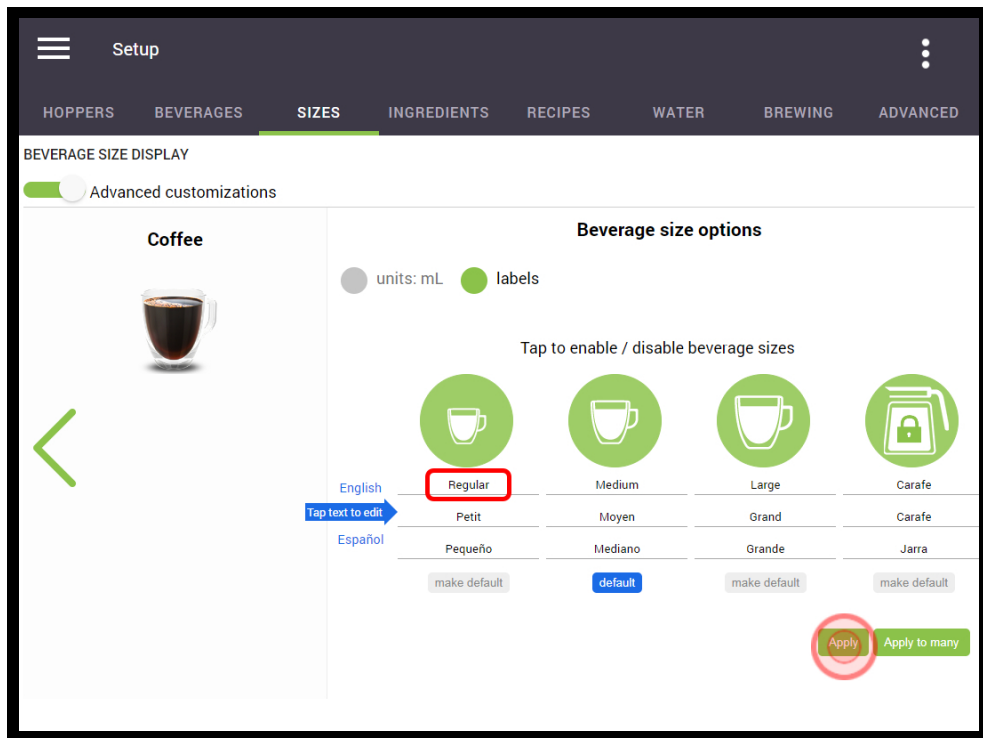

 **Once a label has been changed for one particular beverage, the same change can then be applied to multiple beverages without having to manually change each one.**

- To apply the change(s) you made to multiple beverage, tap on **“Apply to Many”**.

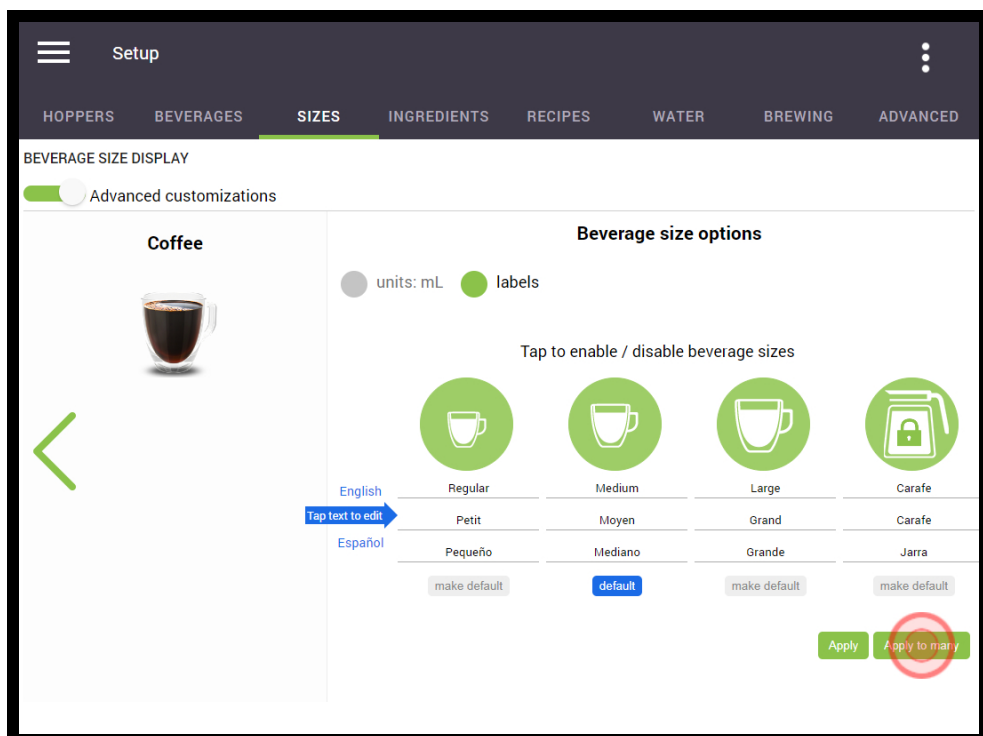

- The screen changes to show all of the available beverages. Tap all of the beverages for which you want the new labels you created to apply. The selected beverage backgrounds will change color to green (like the “Coffee” beverage in the image below).

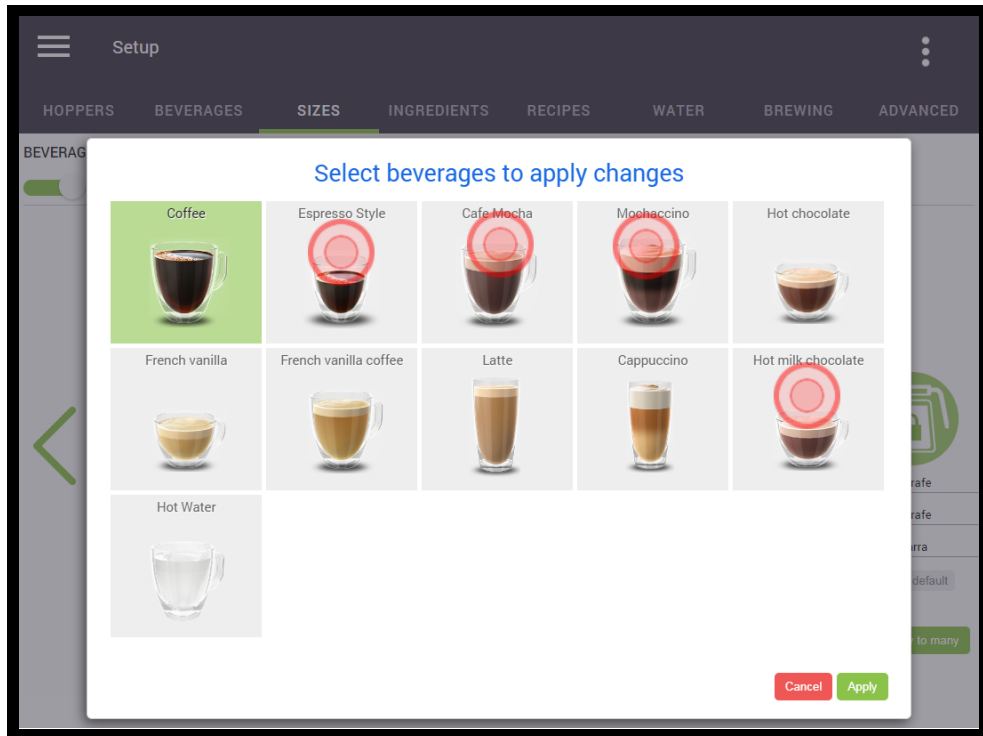

- Once you are done, tap on “Apply” to apply the changes made.

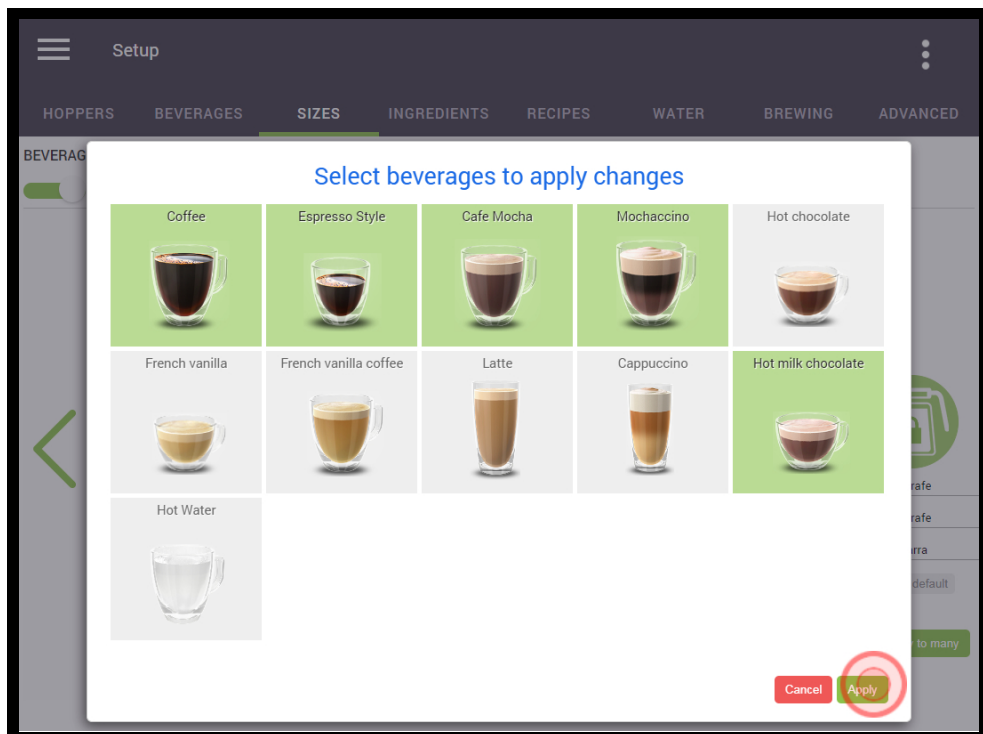

- When you exit the programming mode, all of the custom labels that were created will be visible to the end-user.

Configuring the Carafe

While in the '**Beverages**' tab, you can also configure the carafe option. Simply tap on the carafe icon to change its state.

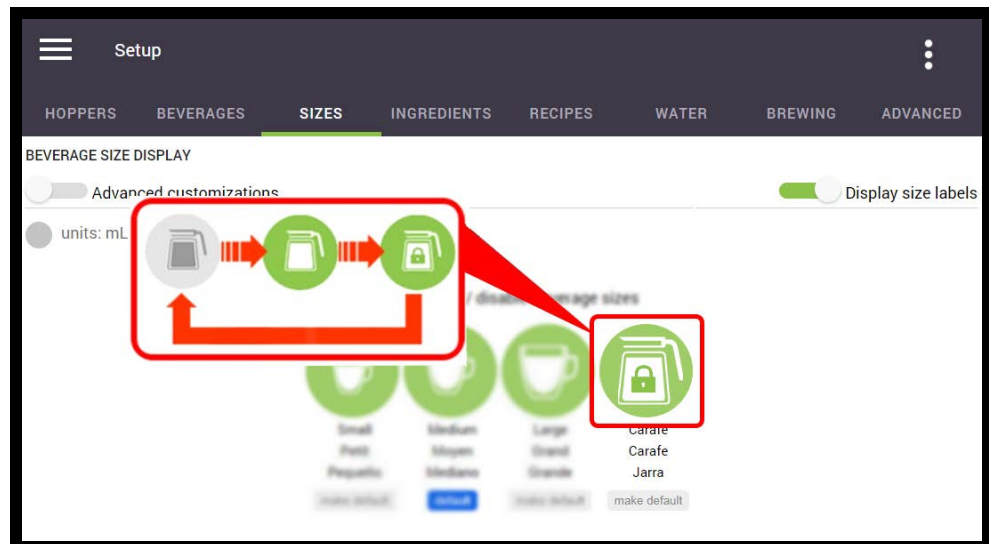

- When the icon is greyed out, the carafe is disabled.
- When the icon is green, the carafe is enabled.
- When the icon is green with an image of a lock in the center, the carafe is active, but requires a PIN to be able to use it. **The PIN can be set in the "Security" menu.**

Ingredients

Should you need to change the name of any of the coffee ingredients, it can be easily done in 'Ingredients' tab. When this tab is selected, a list of the coffee and powder names is displayed. **Please note that only the coffee names can be changed (in all languages), if required.**



The powder names cannot be changed. Changing the powder names in this menu will not change the powder names on the main screen.

Ingredients	Names		
	English	Spanish	French
Coffee 1	French Roast	Mezcla francesa	Mélange français
Coffee 2	Colombian	Colombiano	Colombien
Coffee 1+2	House Blend	Mezcla de la casa	Mélange maison
Coffee 3	Decaf	Decaf	Décafé
Powder 1	Chocolate	Chocolate	Chocolat
Powder 2	Vanilla	Vainilla	Vanille
Powder 3	Milk	Leche	Lait

RESTORE DEFAULTS

1. If, for example, you will be using a Mocha Java coffee blend instead of Colombian, you'll need to modify the '**Coffee 2 Name**' on the list. Tap 'Colombian' on the screen (the current blend name for Coffee 2) to bring up the keyboard.

Ingredients	Names		
	English	Spanish	French
Coffee 1	French Roast	Mezcla francesa	Mélange français
Coffee 2	Colombian	Colombiano	Colombien
Coffee 1+2	House Blend	Mezcla de la casa	Mélange maison
Coffee 3	Decaf	Decaf	Décafé
Powder 1	Chocolate	Chocolate	Chocolat
Powder 2	Vanilla	Vainilla	Vanille
Powder 3	Milk	Leche	Lait

RESTORE DEFAULTS

- With the cursor at the end of the Colombian text, press the **'backspace'** button until all of the text is deleted.

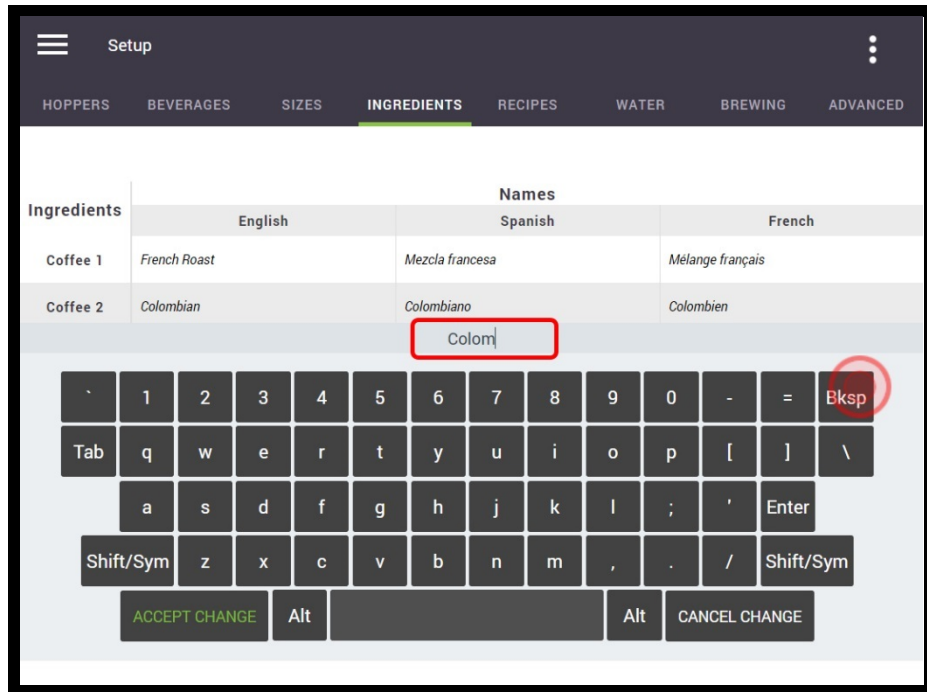

- When the text is deleted, **'Coffee 2 English Name'** is displayed in this field instead of an actual blend name. Using the keyboard, type in the new name for Coffee 2 - which in this case changes to **'Mocha Java'**.

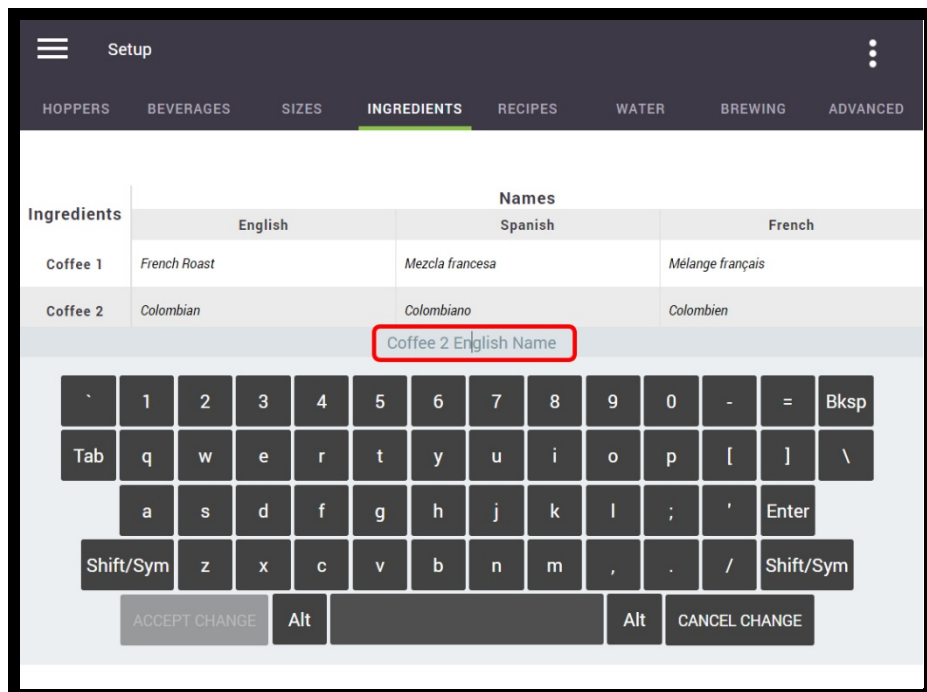

** The same procedure for renaming the coffees must also be repeated in Spanish and French columns.*

4. Tap the 'Accept Change' button to save your changes.

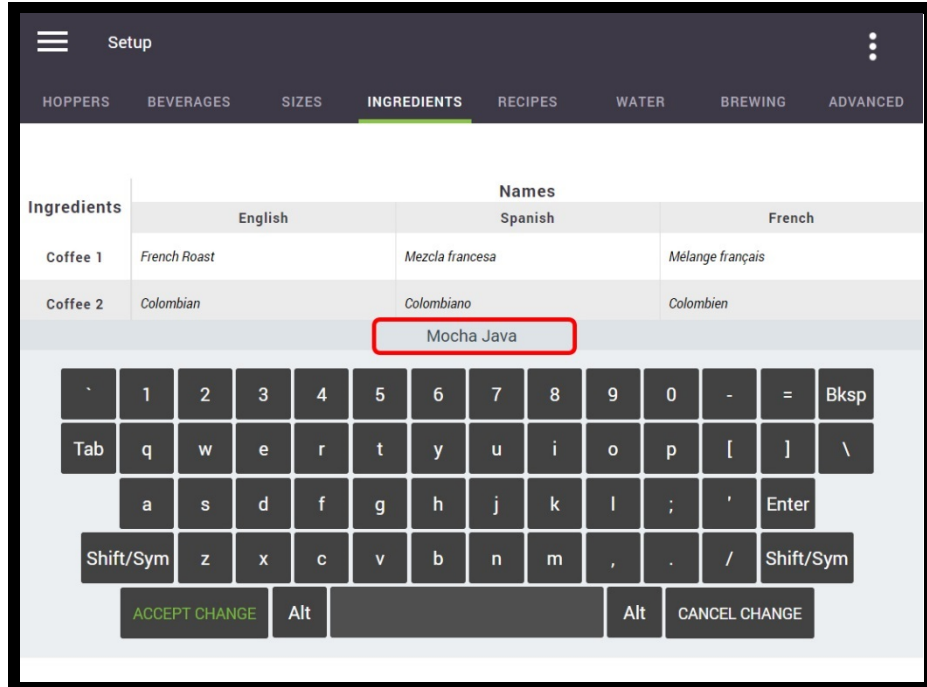

5. Coffee 2 has now been renamed from Colombian to Mocha Java on the list of ingredients.

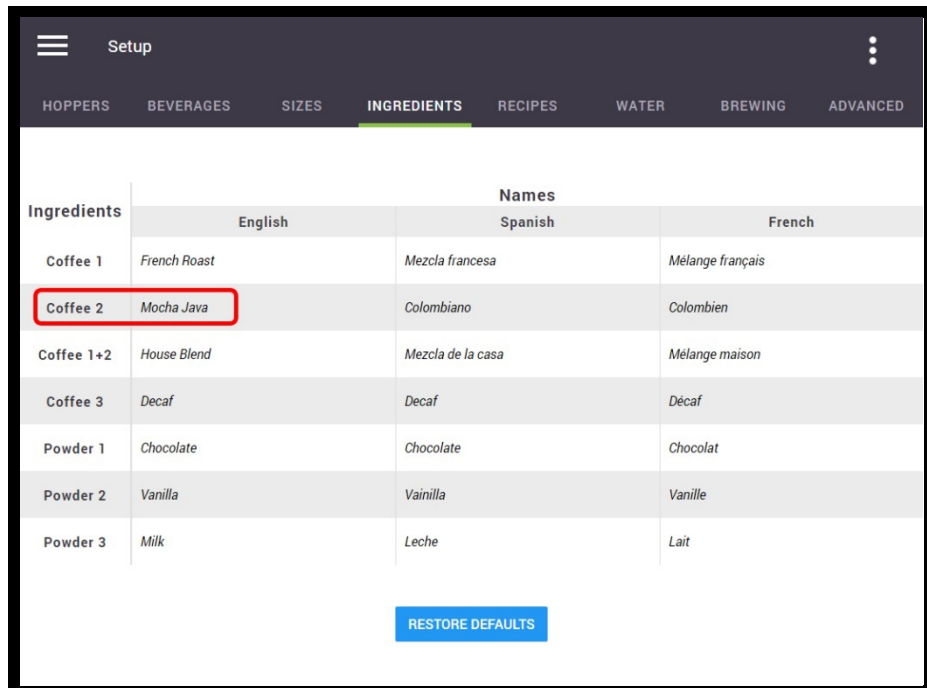

6. 'Mocha Java' is now displayed everywhere 'Colombian' was previously displayed.

Recipes

The product settings for every available beverage can be adjusted in the 'Recipes' tab of the setup.

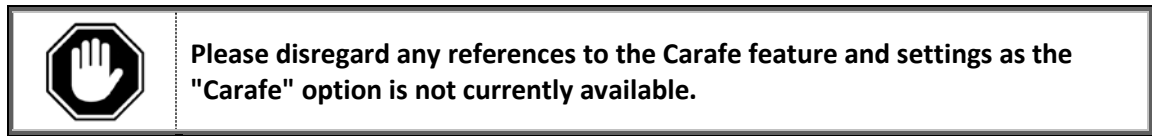

Setting Coffees

1. Tap on the 'Selected Beverage' location beside Line 1.

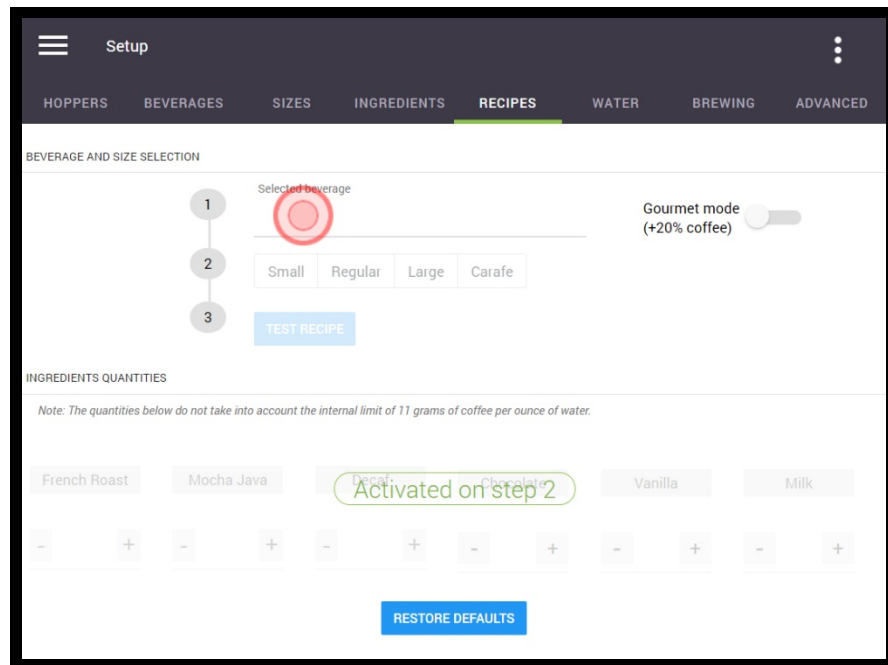

2. A scroll list of all the available beverages appears.

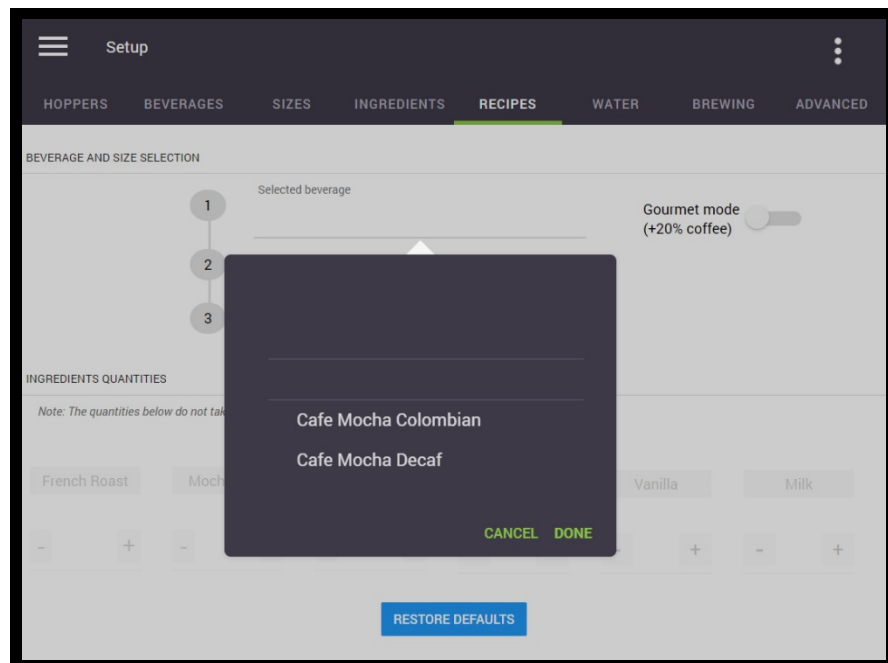

- Swipe up or down to scroll through the list of beverages and then select the one that requires adjusting by tapping 'Done'. In this example, 'Coffee French Roast' is selected.

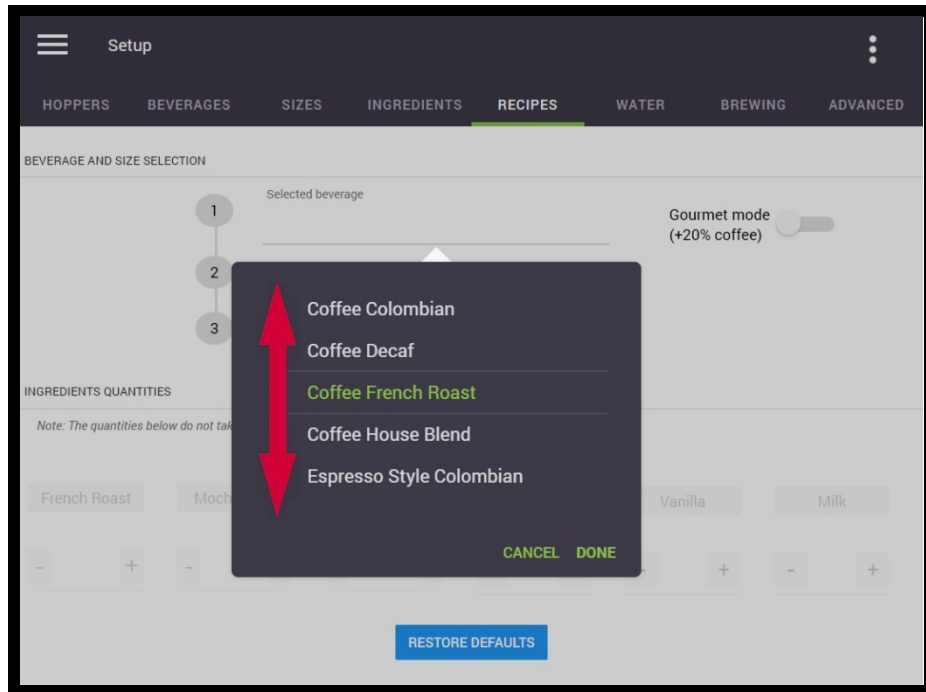

- On Line 2, select the cup size that needs to be adjusted. In this example, the 'Regular' cup size is selected.

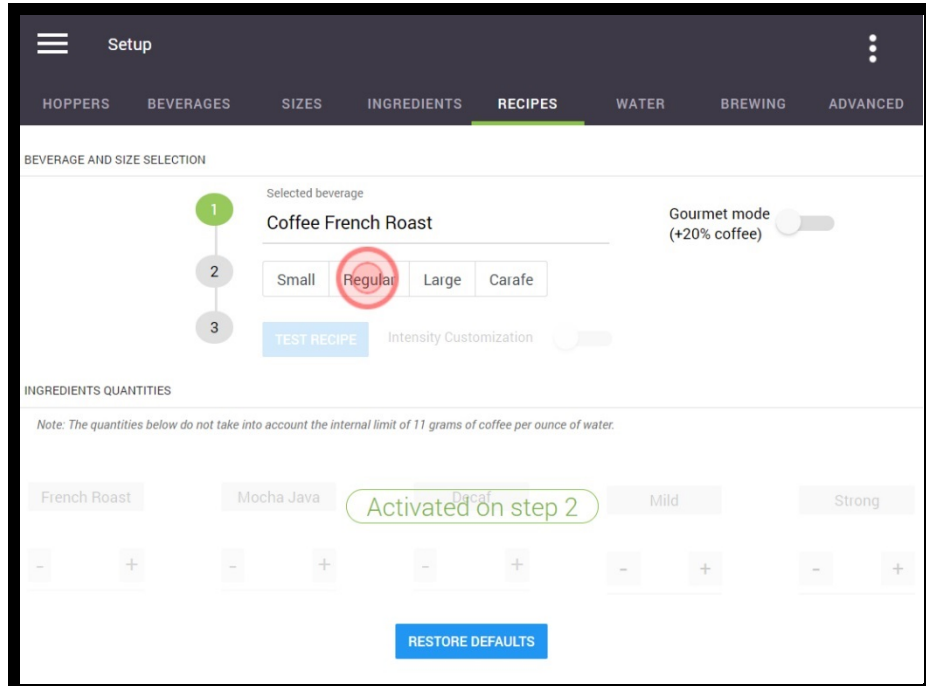

Notice that the French Roast setting is now active (not grayed out) in the 'Ingredients Quantities' section of the screen. This indicates that this setting can now be adjusted. Also note the 'Intensity Customization' setting on Line 3. This is used to adjust the 'Mild' and 'Strong' strength coffee settings. Tap on the slider to activate it.

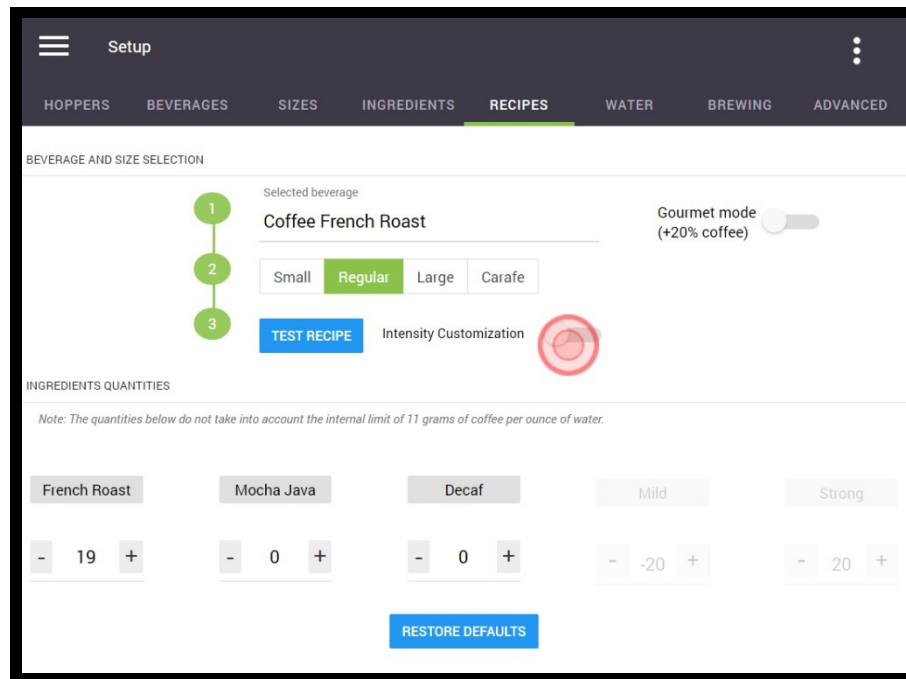

- The 'Mild' and 'Strong' settings are now also active (not grayed out) in the 'Ingredients Quantities' section of the screen.

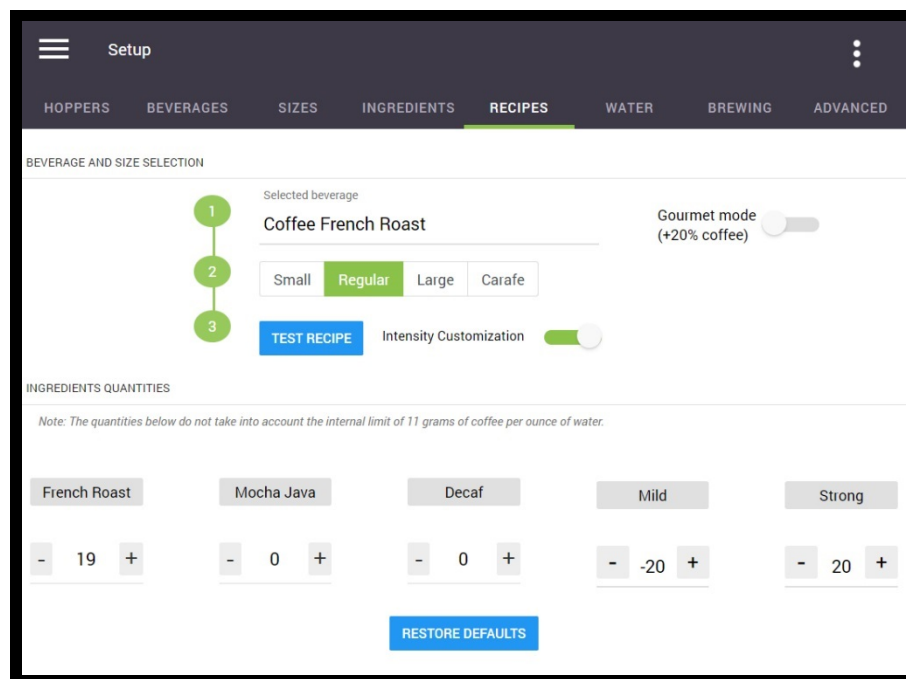



Coffee settings are measured in grams, whereas the 'Intensity' settings are measured as a percentage of the coffee setting - 'Mild' is a percentage decrease, whereas 'Strong' is a percentage increase.

6. In our example, we will increase the French Roast coffee setting for a medium cup size to 20 grams.

The screenshot shows the 'Setup' interface for coffee recipes. The 'RECIPES' tab is active. The selected beverage is 'Coffee French Roast' in 'Regular' size. The 'French Roast' ingredient quantity is set to 20 grams, highlighted with a red circle. Other ingredients like Mocha Java, Decaf, Mild, and Strong are set to 0, -20, and 20 respectively. A 'TEST RECIPE' button and 'RESTORE DEFAULTS' button are visible.

7. We also want to adjust the 'Mild' strength setting so that it is -15% milder instead of -20% milder by increasing (+) the 'Mild' setting. The 'Strong' setting percentage can also be increased or decreased.

The screenshot shows the 'Setup' interface for coffee recipes. The 'RECIPES' tab is active. The selected beverage is 'Coffee French Roast' in 'Regular' size. The 'Mild' ingredient quantity is set to -15, highlighted with a red circle. Other ingredients like French Roast, Mocha Java, Decaf, and Strong are set to 20, 0, 0, and 20 respectively. A 'TEST RECIPE' button and 'RESTORE DEFAULTS' button are visible.



Mild strength settings are shown as a negative (-) number as the actual coffee setting is decreased by the percentage shown.

- To brew a test beverage using the new settings, place a cup on the cup stand and tap on the blue 'Test Recipe' button on line 3. The Momentum™ will now dispense the beverage so that you or your customer can perform a taste test. If further adjustments are required, make the changes and test the beverage again until you get the desired results.

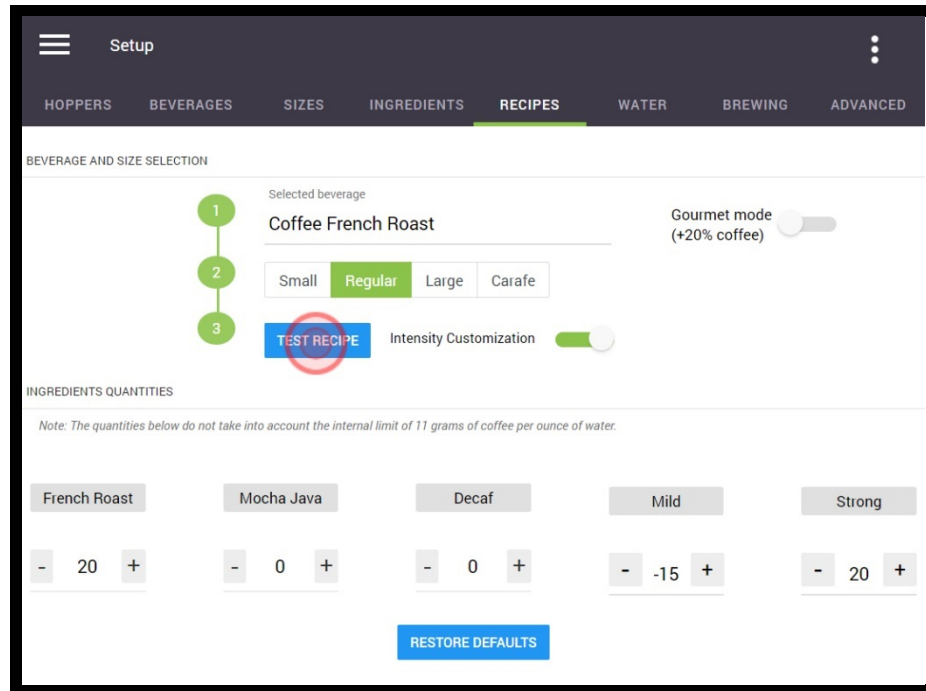

Gourmet Mode

When enabled, the “Gourmet mode” option adds **20% more coffee** into all coffee-based beverage recipes, giving these beverages an even bolder coffee taste.

To enable/disable this mode, tap the “Gourmet Mode” slider.

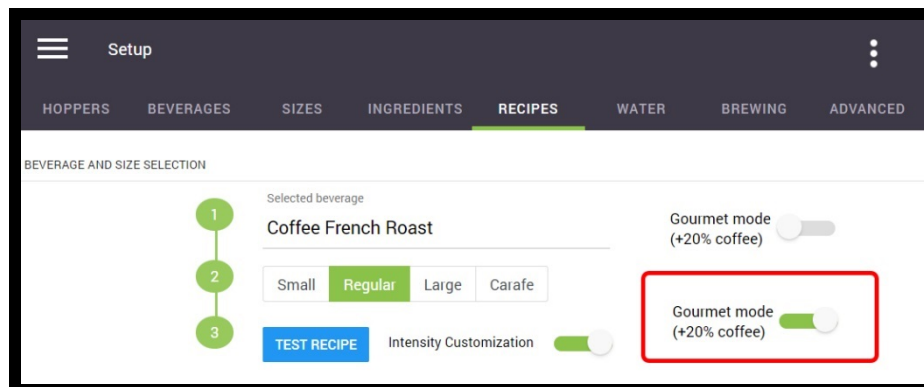

Setting Specialty Beverages

1. Tap on the 'Selected Beverage' location beside Line 1.

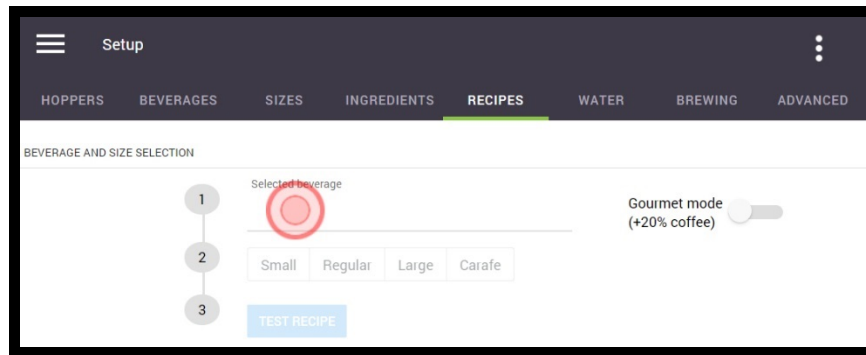

2. A scroll list of all the available beverages appears.

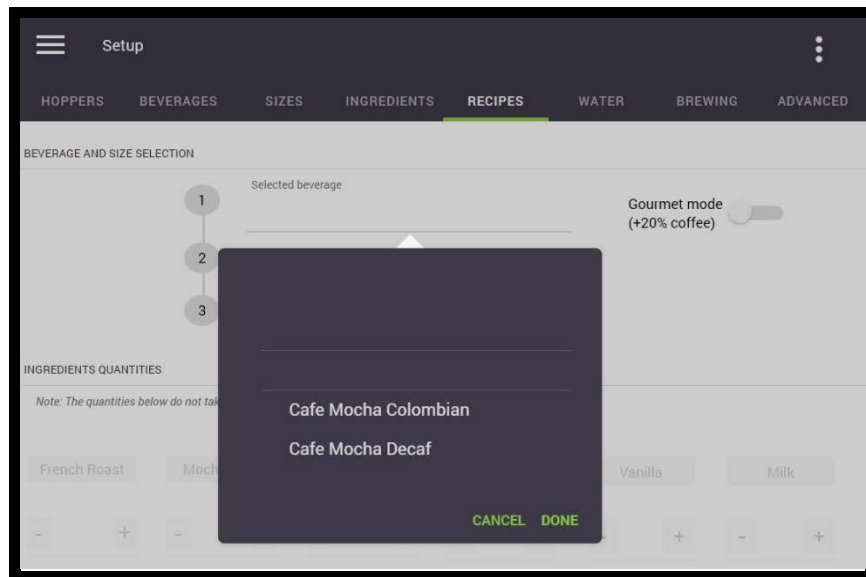

3. Swipe up or down to scroll through the list of beverages, select the one that requires adjusting and then by tap 'Done'. In this example, 'Mochaccino French Roast' is selected.

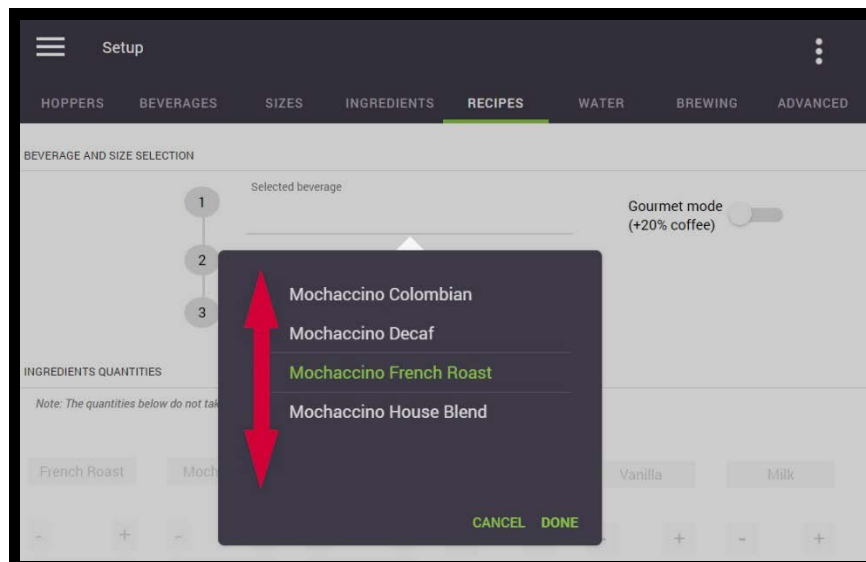

- On Line 2, select the cup size that needs to be adjusted. In this example, the 'Small' cup size is selected.

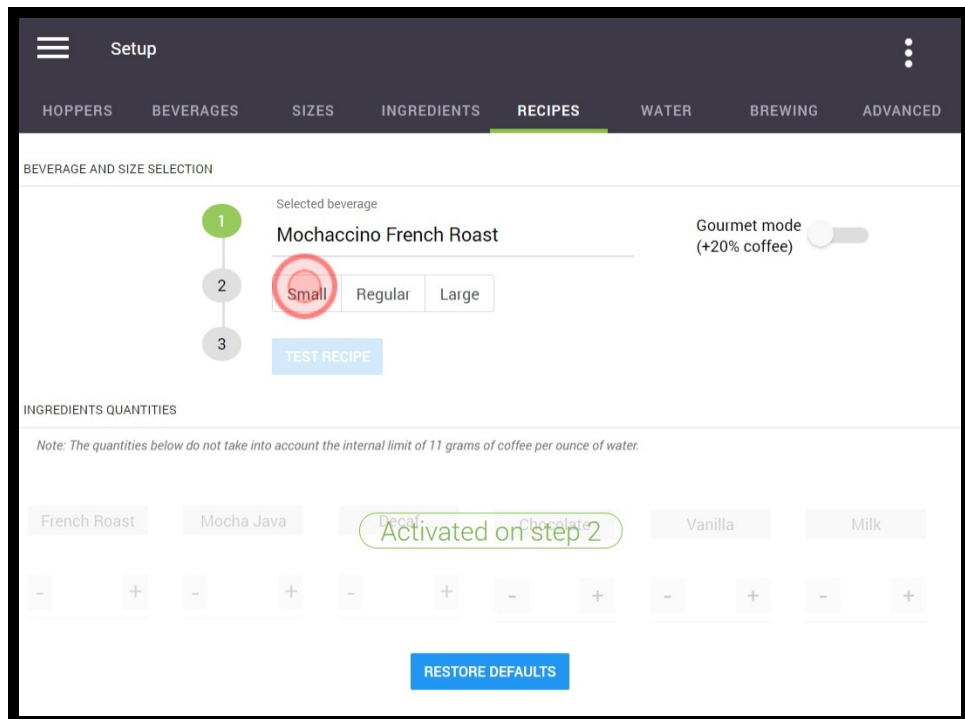

- Notice that all of the ingredients required to make a Mochaccino French Roast are now active (not grayed out) in the 'Ingredients Quantities' section of the screen. This indicates that each of these ingredients can now be individually adjusted.

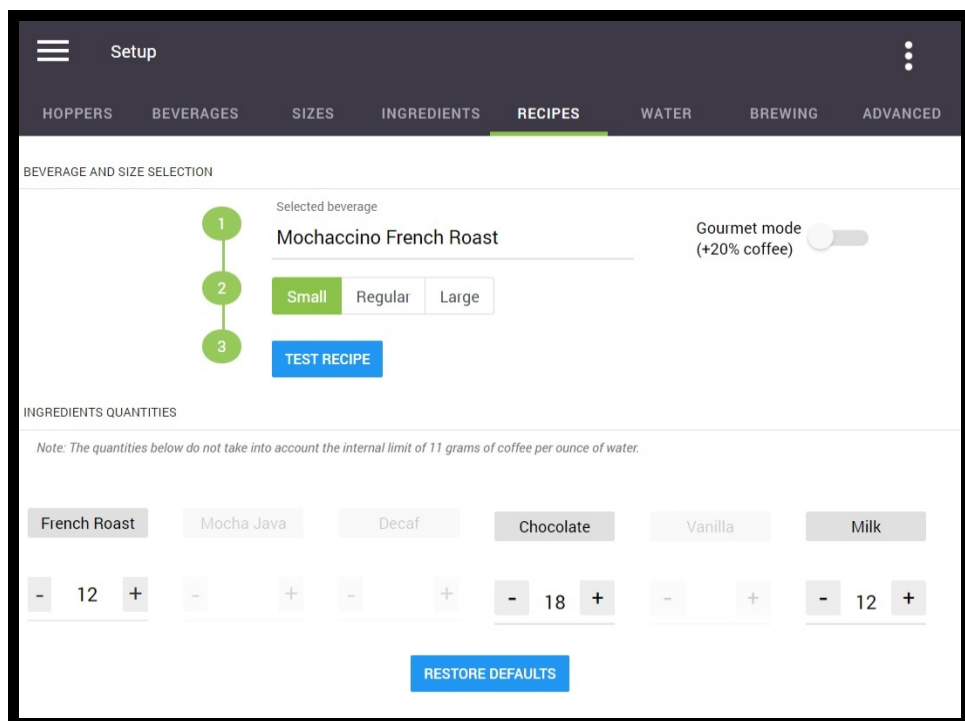

6. In our example, we will slightly increase the French Roast coffee to 15 grams, but we will increase the chocolate to 20 grams, while leaving the milk untouched.

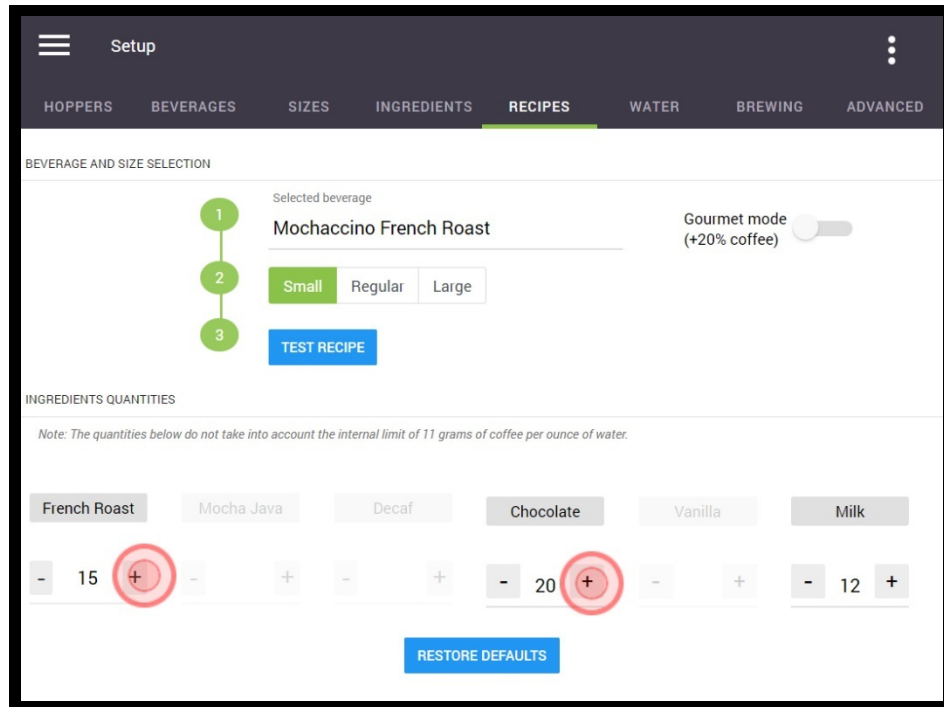

7. To brew a test beverage using the new settings, place a cup on the cup stand and tap on the blue 'Test Recipe' button on line 3. The Momentum™ will now dispense a Mochaccino French Roast that you or your customer can taste test. If further adjustments are required, make the changes and the test the beverage again until you get the required results.

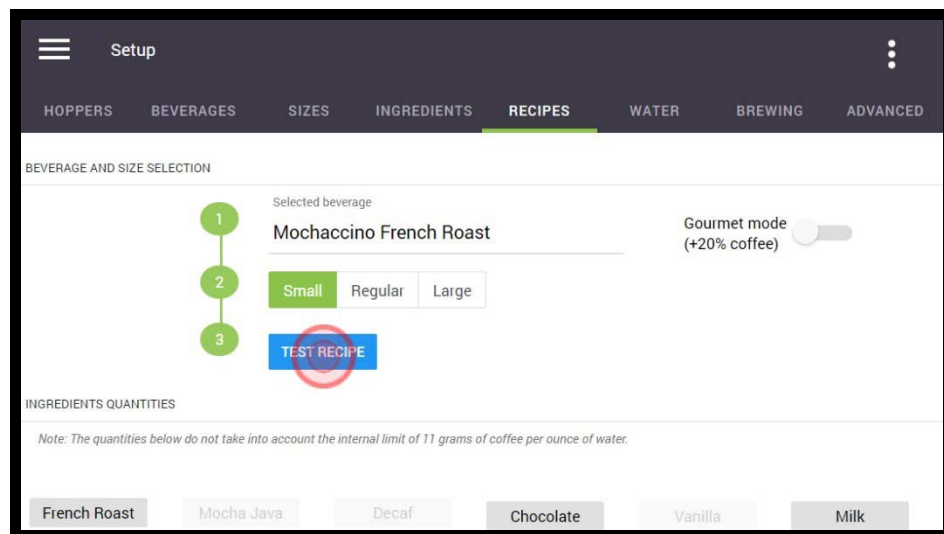

Disabling “Press & Hold” Hot Water

If you would like to dispense hot water by the cup and/or to add a price for “Hot Water”, you’ll need to disable the “Press & Hold” setting. Select “Hot Water” as the beverage in Line 1, then set the “Press & Hold” slider to the Off position.

Restore Defaults

Should you need to restore the default settings of a certain beverage, select that beverage in the 'Recipes' tab, as well as a cup size, and then tap the 'Restore Defaults' button.

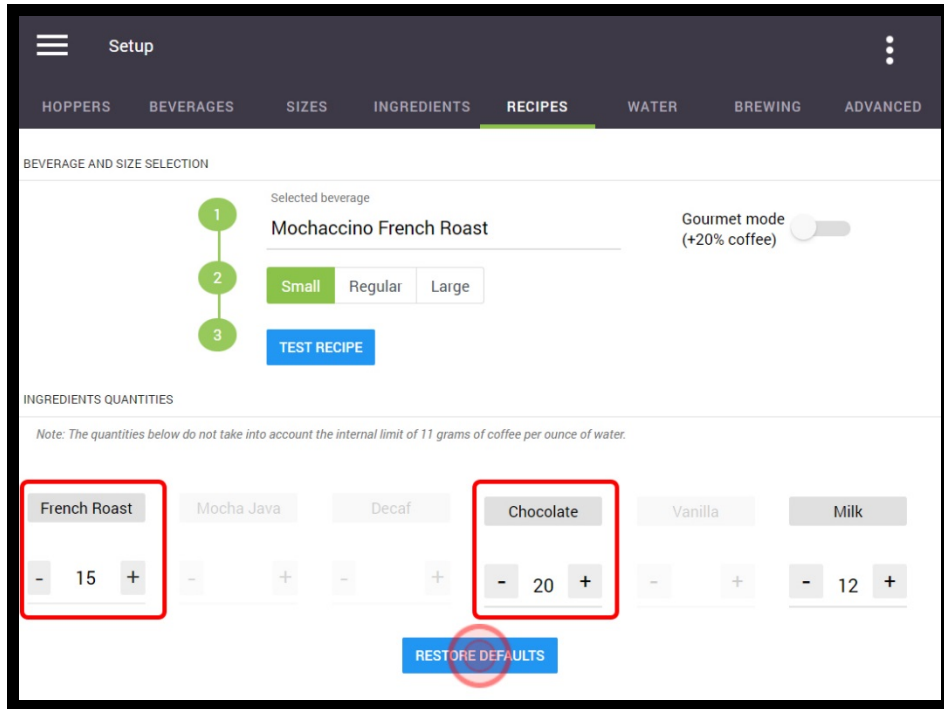

The Factory Settings for **only** that particular selection will be restored.

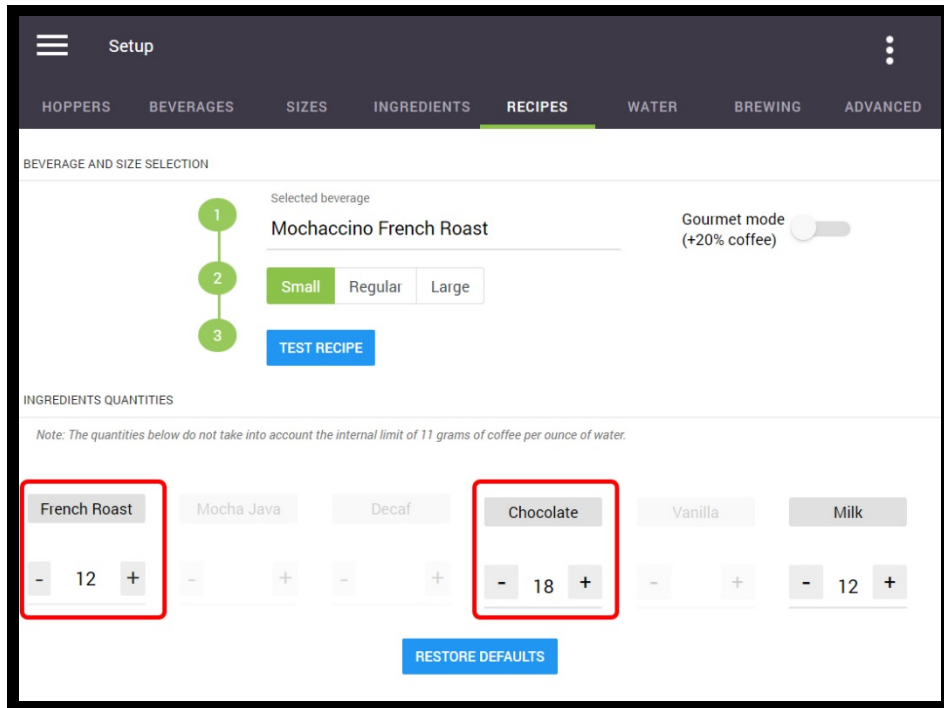

 **When the factory settings are restored for a selection, any changes that were made to your previous settings will be overwritten.**

Water

The water settings for every available beverage can be adjusted in the 'Water' tab of the setup.



The Momentum™ is factory preset to dispense 12-oz, 16-oz, and 20-oz cups sizes. These settings can be changed in this menu.

1. After selecting the 'Water' tab, the following options appear - Coffees, Specialty Coffees, and Powder Beverages. Select the **type of beverage** for which you want to adjust the water. In this example, '**Specialty Coffees**' is selected.

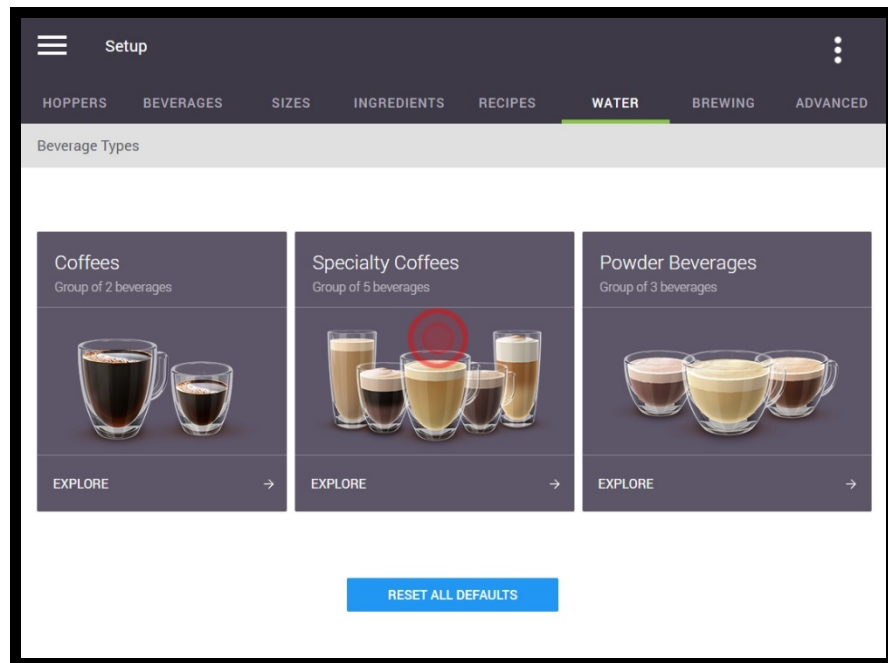

2. Select the **specific beverage** for which you want to adjust the water. In this example, '**Mochaccino**' is selected.

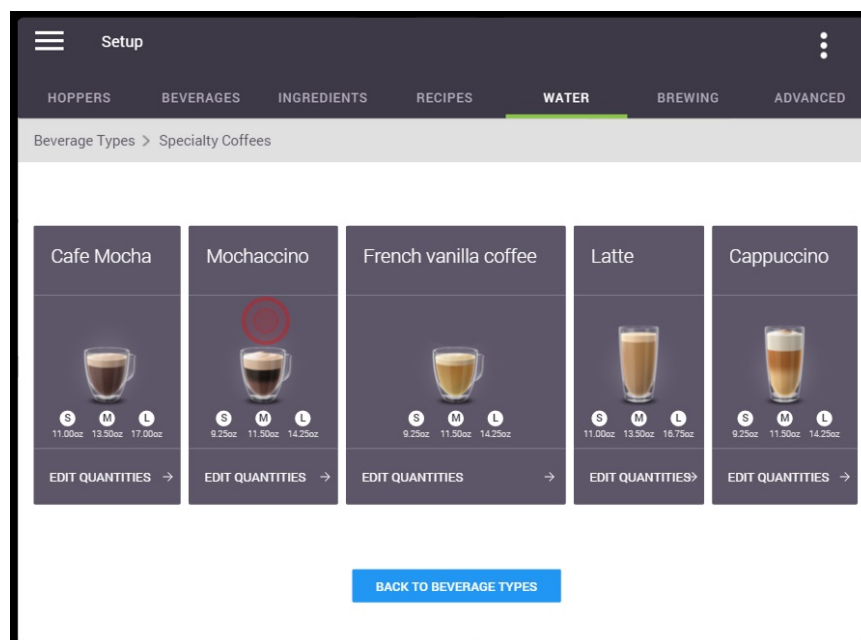

- All three cup sizes are now displayed. To increase or decrease the quantity of water for a specific cup size, press the '-' or '+' buttons in the corresponding box.

In this example, the **'Medium'** cup size will be increased to 12.25-oz. Press the '+' button in the **'Medium'** box until **12.25** is displayed.

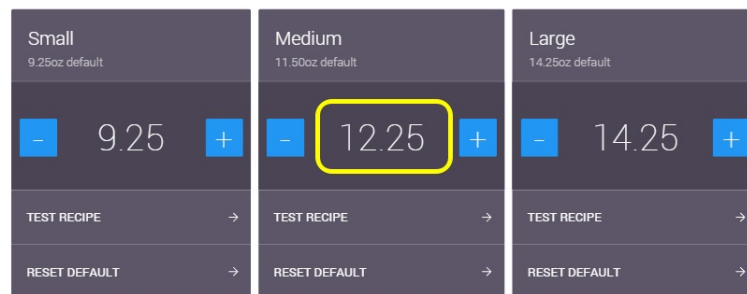
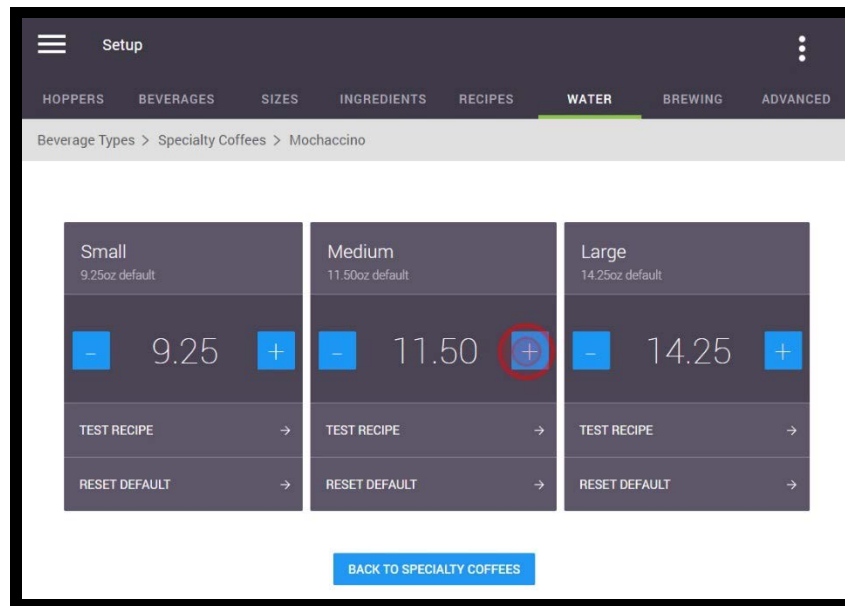

- Place a cup on the cup stand and tap on the **'Test Recipe'** button to make a test vend with the new water settings. Make any adjustments, if necessary.

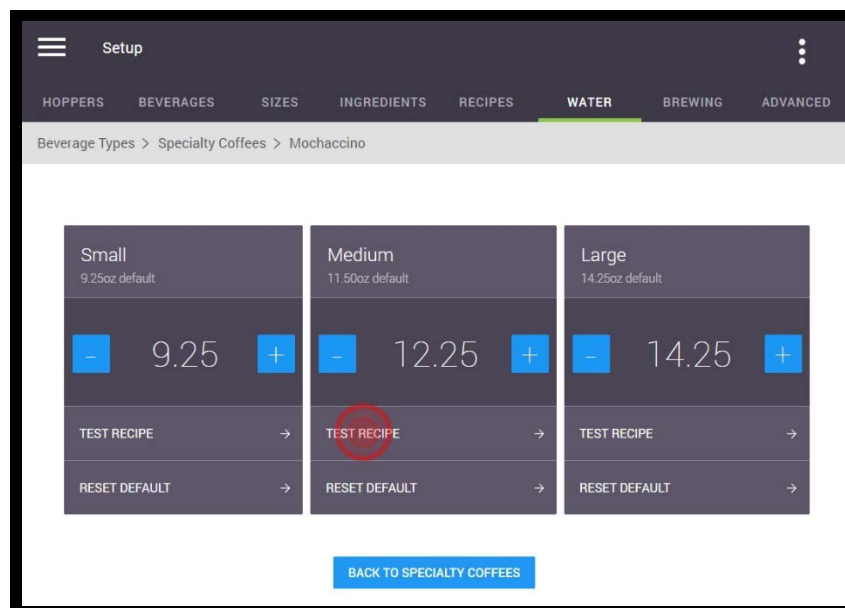

5. To reset a specific setting back to its default, press the **'Reset Default'** setting for the corresponding cup size. *The original default setting is shown beneath each cup size.*

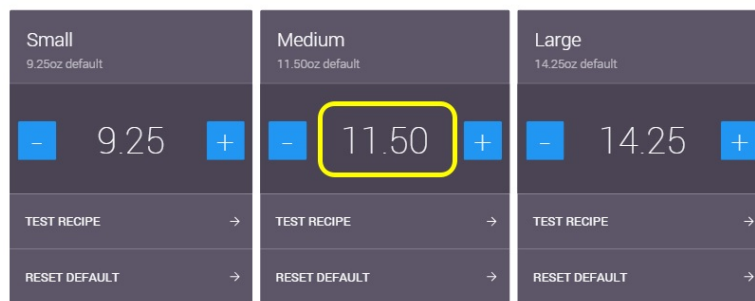
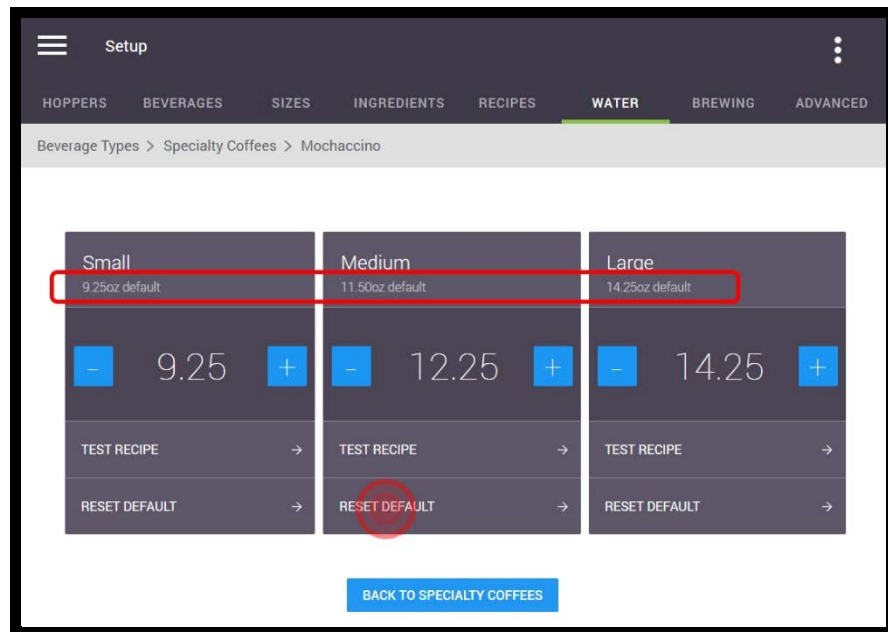

6. To return to the 'Specialty Coffees' screen, tap the **'Back to Specialty Coffees'** button.

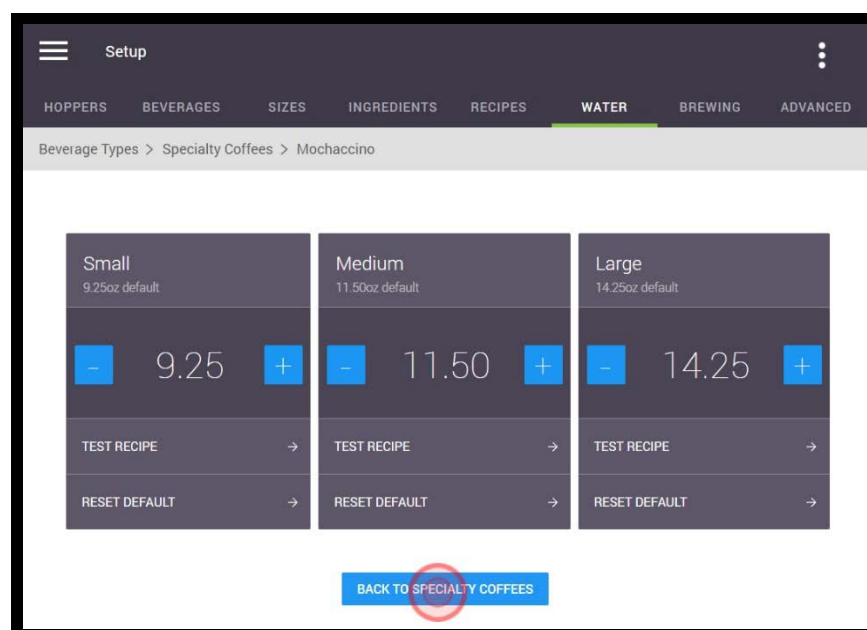

- From this screen, either select another specialty beverage to adjust, or tap the 'Back to Beverage Types' button to return to the main screen.

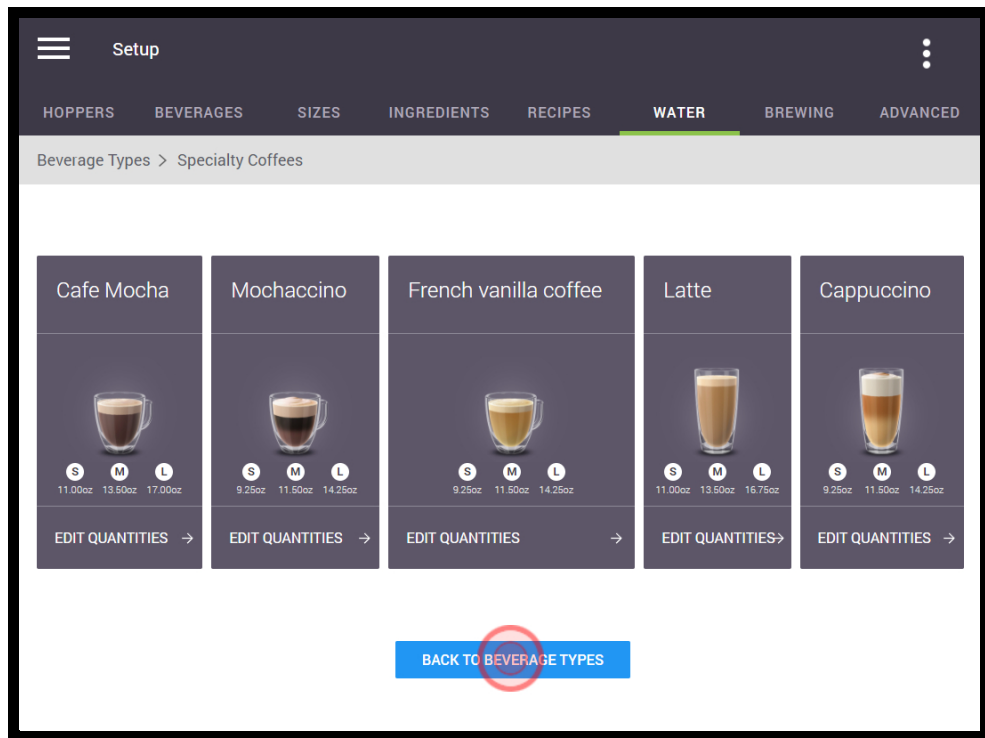

- Make another selection and repeat the water adjustment process, if required.

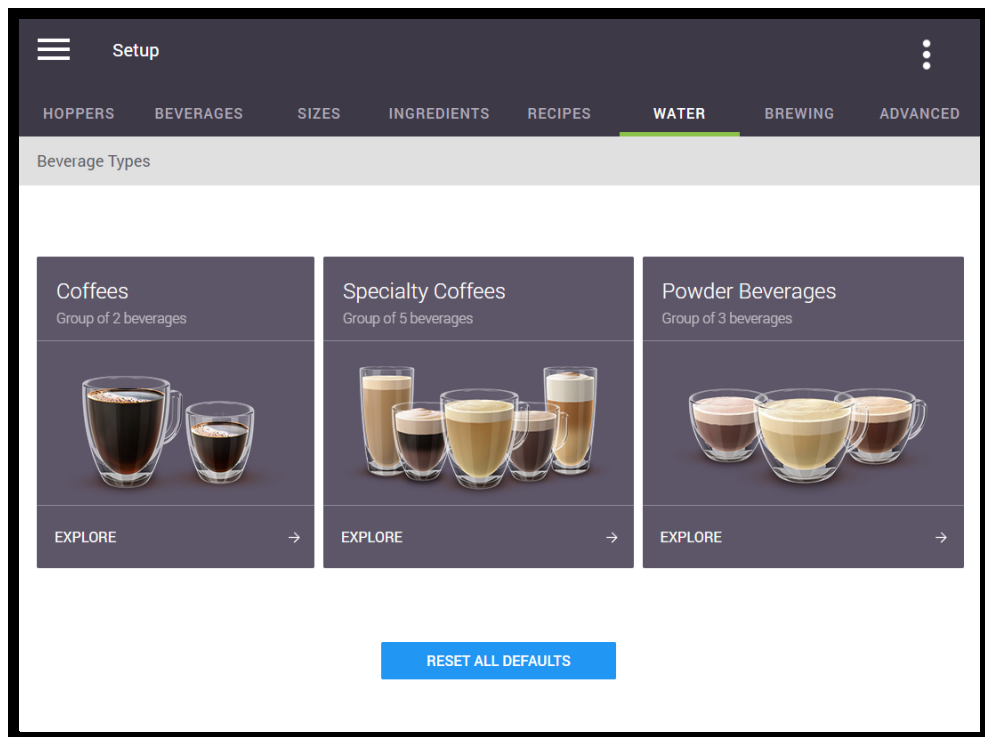

9. The following screen appears if 'Coffees' is selected from the main screen:

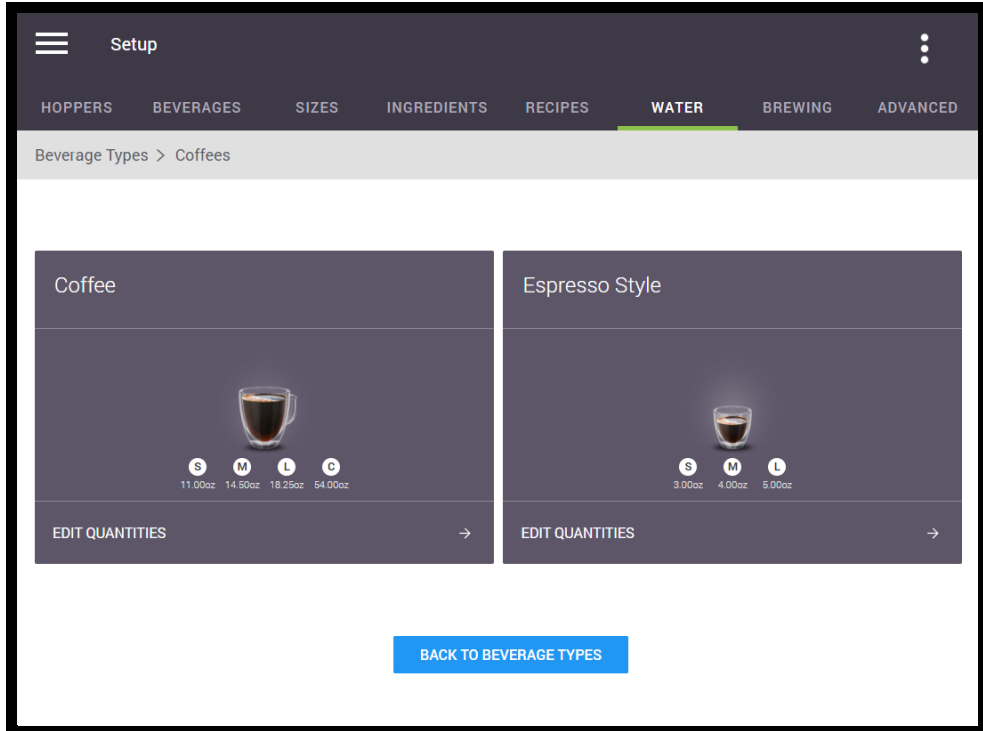

10. The following screen appears if 'Powder Beverages' is selected from the main screen:

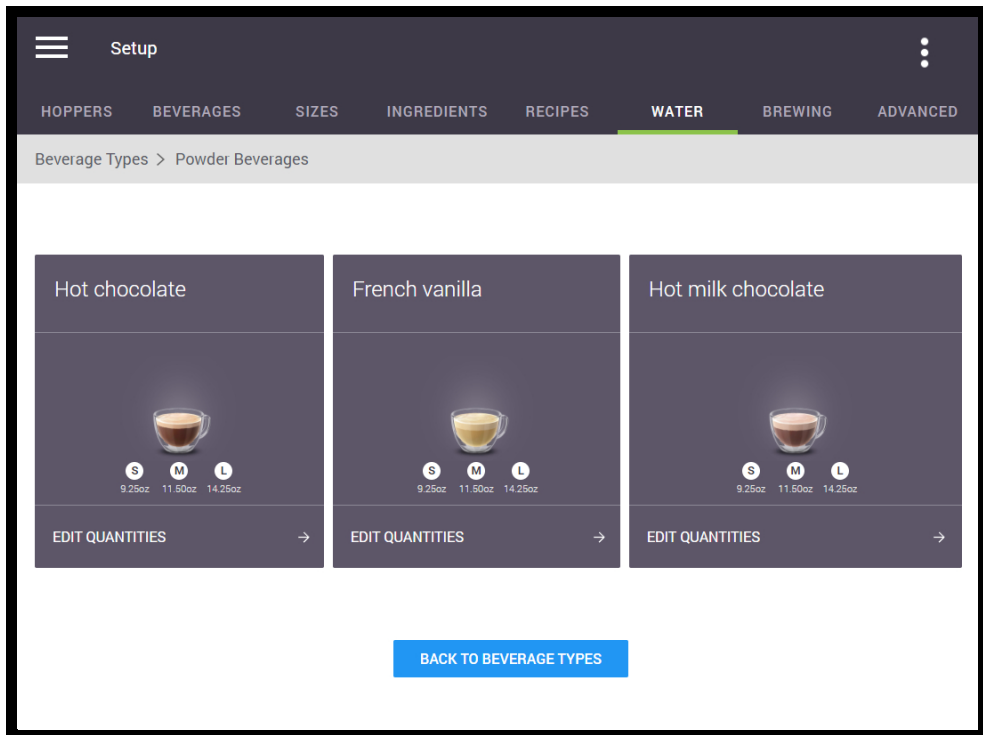

- Should you need to reset **all of the water settings back to their default settings at the same time**, you can do so from the main 'Water' screen simply by tapping on the 'Reset all Defaults' button.

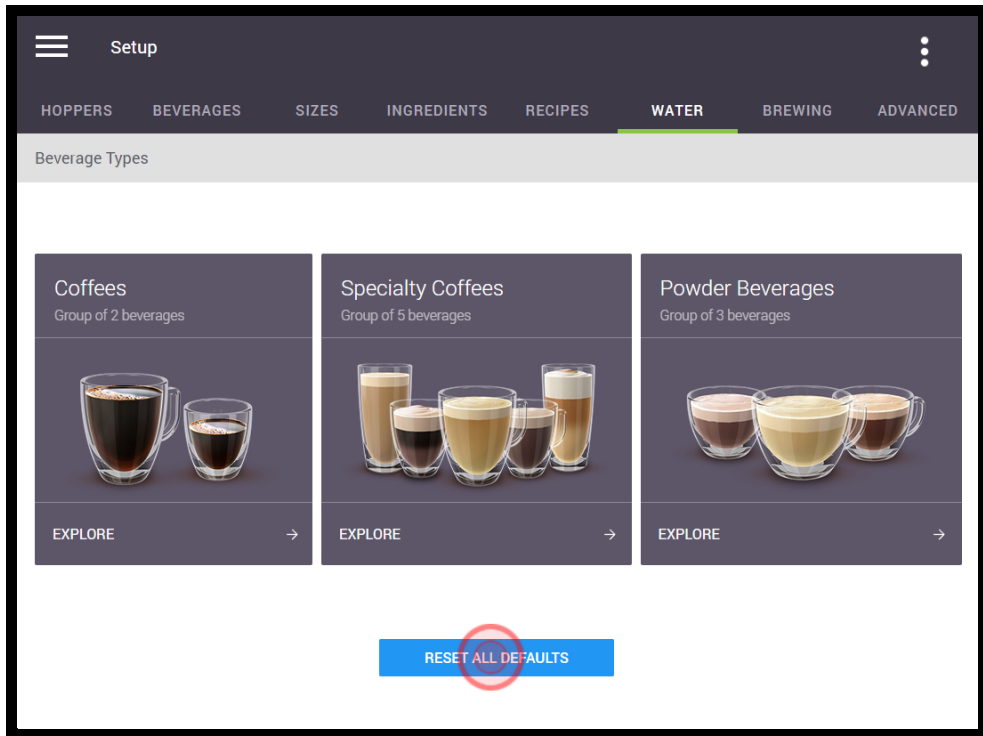

Brewing

All water temperature related settings are set in this tab.

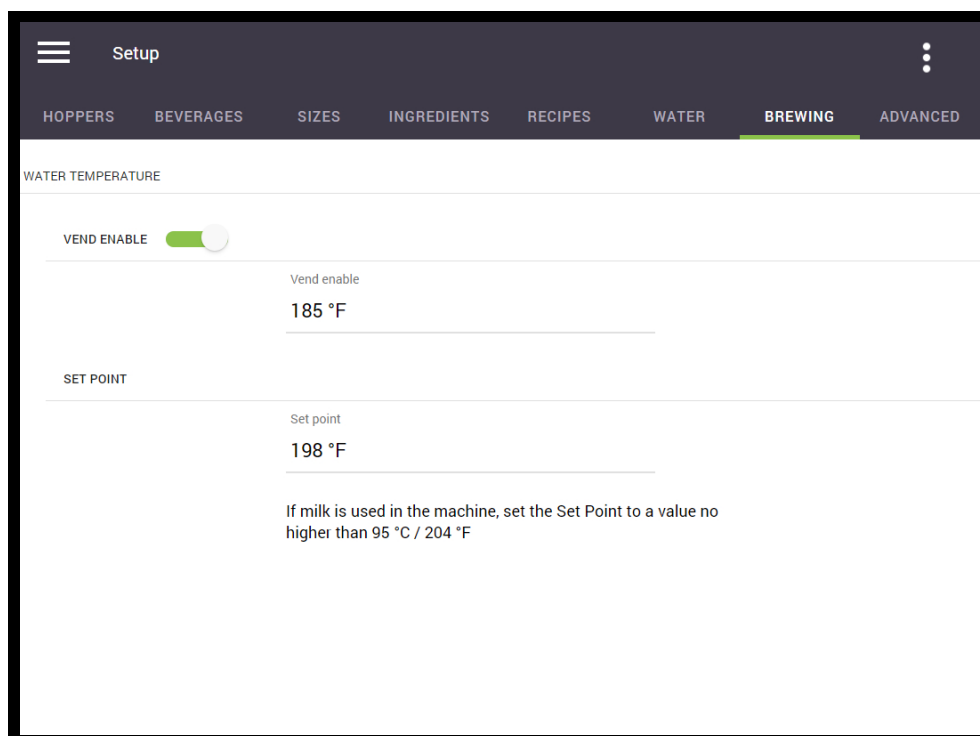

Water Temperature

Vend Enable

By activating and setting the '**Vend Enable**' feature, you are setting the minimum temperature at which the machine will brew a beverage. Should the temperature drop below this setting, you will not be able to brew a beverage and the screen will display a 'Tank is Heating' message.

Set Point

The '**Set Point**' is the temperature at which the heating system maintains the water in the tank.

To change either the '**Vend Enable**' or '**Set Point**' temperatures, tap on the temperature setting and use the scroll list to change the setting and press '**Done**' to save it.

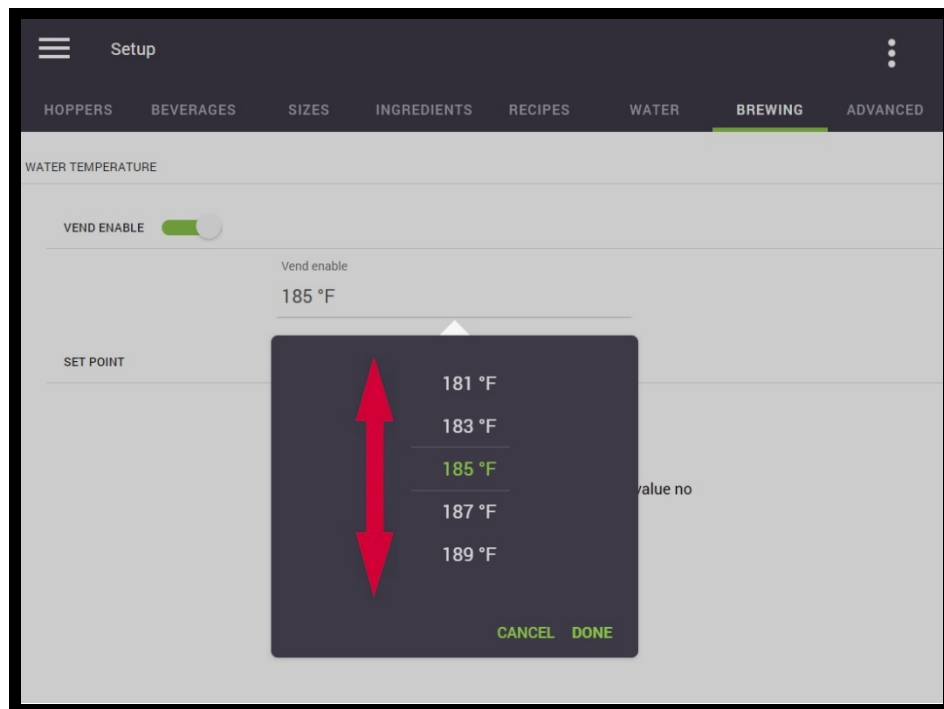

Advanced (Beverage Set Selection)

In this tab, you can choose the beverage set (set of cup sizes) required by tapping the “Change Beverage Set” tab. Select the beverage set required (see list) and tap ‘Save’.

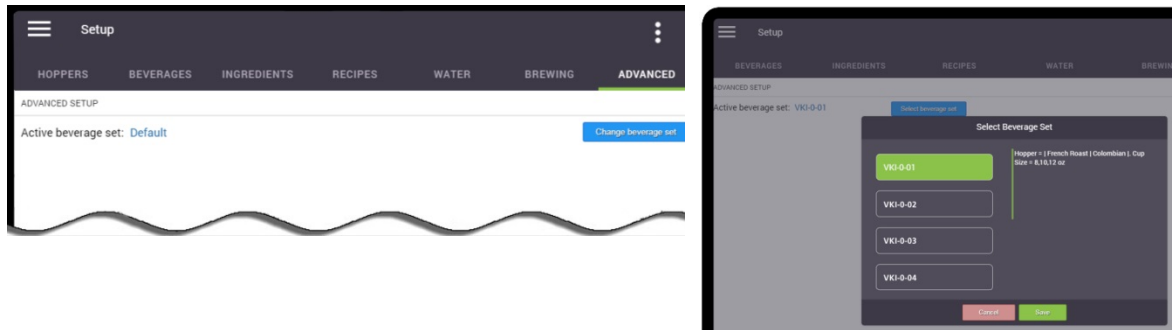

Beverage Set List (Default)

Name	Cup Sizes	Left hopper	Middle hopper	Right hopper	50/50 Blend
VKI-1-01	10, 12, 16 oz	French Roast	French Roast Decaf	Colombian	House Blend
VKI-2-01	12, 16, 20 oz	French Roast	French Roast Decaf	Colombian	House Blend
VKI-3-01	16, 20, 24 oz	French Roast	French Roast Decaf	Colombian	House Blend
GMCR-1-01	10, 12, 16 oz	Dark Magic	Breakfast Blend Decaf	Breakfast Blend	50/50 Blend
GMCR-1-02	10, 12, 16 oz	Sumatra Reserve	Breakfast Blend Decaf	Breakfast Blend	50/50 Blend
GMCR-2-01	12, 16, 20 oz	Dark Magic	Breakfast Blend Decaf	Breakfast Blend	50/50 Blend
GMCR-2-02	12, 16, 20 oz	Sumatra Reserve	Breakfast Blend Decaf	Breakfast Blend	50/50 Blend
GMCR-3-01	16, 20, 24 oz	Dark Magic	Breakfast Blend Decaf	Breakfast Blend	50/50 Blend
GMCR-3-02	16, 20, 24 oz	Sumatra Reserve	Breakfast Blend Decaf	Breakfast Blend	50/50 Blend
LaughingMan-1-01	10, 12, 16 oz	Colombia Huila	Breakfast Blend Decaf	Dukale's Blend	50/50 Blend
LaughingMan-2-01	12, 16, 20 oz	Colombia Huila	Breakfast Blend Decaf	Dukale's Blend	50/50 Blend
LaughingMan-3-01	16, 20, 24 oz	Colombia Huila	Breakfast Blend Decaf	Dukale's Blend	50/50 Blend
Tullys-1-01	10, 12, 16 oz	French Roast	Breakfast Blend Decaf	House Blend	50/50 Blend
Tullys-2-01	12, 16, 20 oz	French Roast	Breakfast Blend Decaf	House Blend	50/50 Blend
Tullys-3-01	16, 20, 24 oz	French Roast	Breakfast Blend Decaf	House Blend	50/50 Blend

Security

The Security screen is used to assign or change PIN numbers, and grant/remove access to individual sections of the machine programming.

There are two tabs on this screen - Administrator and Operator. The **Operator** is generally the owner of the equipment, and the **Administrator** is the person responsible for the equipment at the account. The Operator has complete access to the programming menus and sets the rights for the Administrator, who has limited access.

In the example below, you'll notice that the Administrator has only two accessible menus, while the Operator has access to all of the menus. **It is the Operator who decides what access is granted to the Administrator**, and in this case, the Administrator only has access to the Dashboard and General menus.

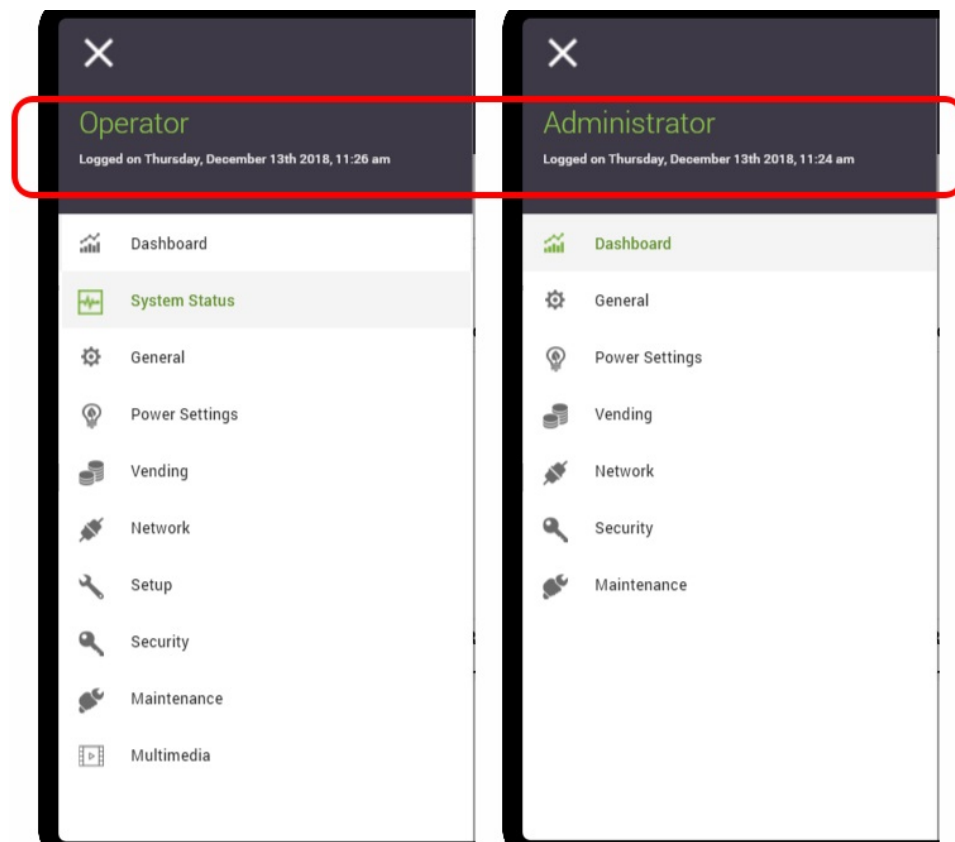

The information in the Operator section applies only to someone logged in as an Operator. If logged in as an Administrator, the Operator tab is not accessible to you.

Administrator

The Administrator can set or change their own PIN number in this tab.



The default pin for the Administrator is '234567'. We recommend that you change this pin on the machine's initial set-up. ***Store the new PIN information somewhere where it can easily be found (in your customer's file, for example)!***

1. Tap on 'New Pin' (or change PIN, if changing it) to open the numeric keypad.

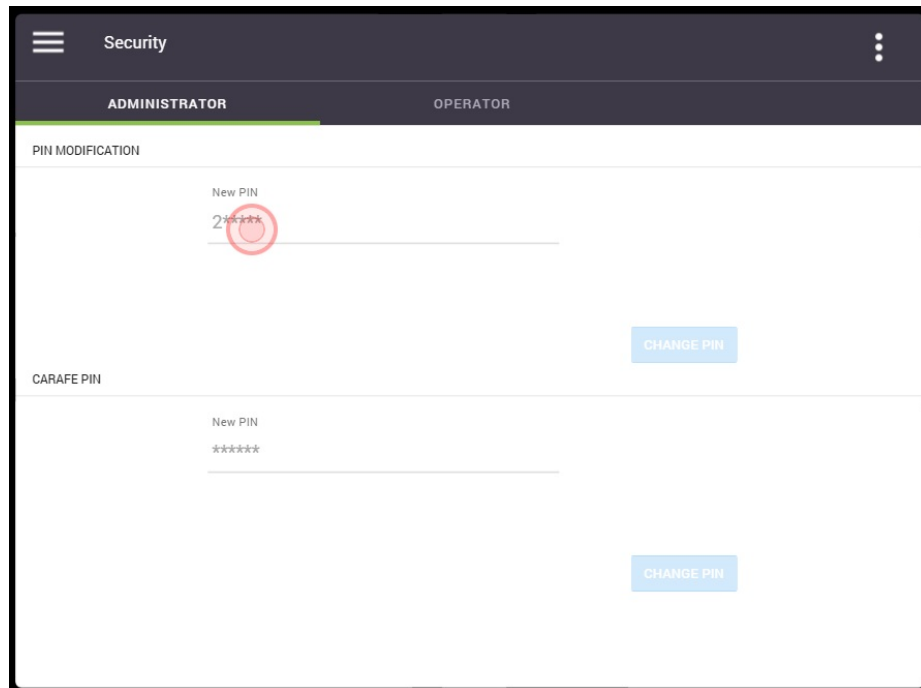

2. Using the keypad, enter a 4-6 digit PIN and tap on 'Accept Change'.

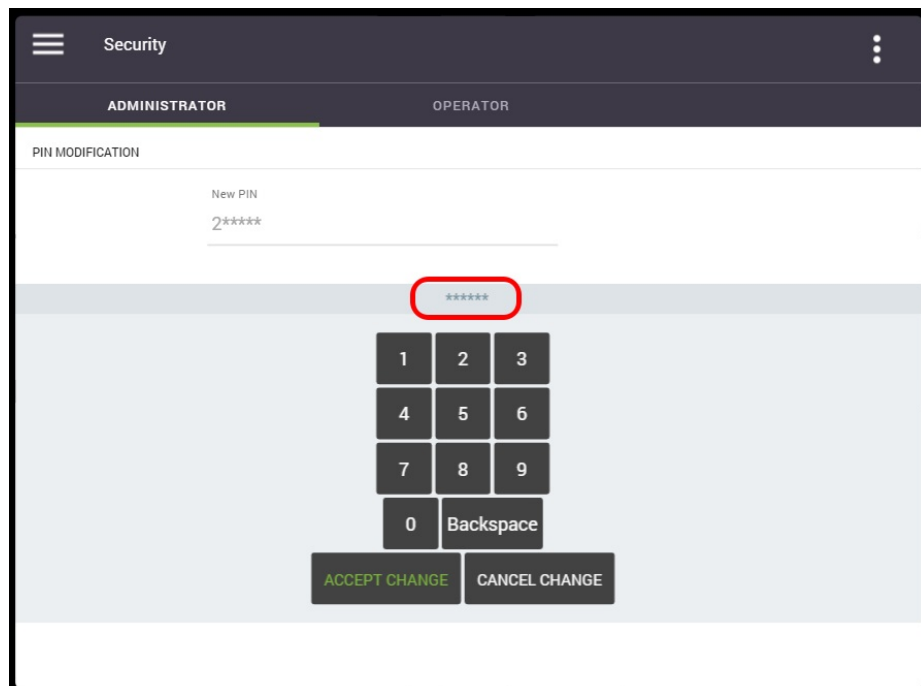

3. Tap on 'Confirm PIN', and re-enter the same PIN on the keypad, and then tap on 'Accept Change'.

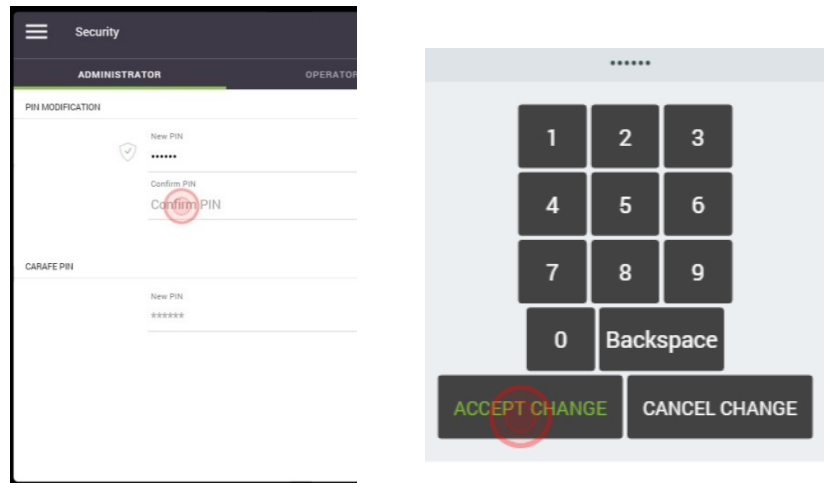

4. If the PINs matches, you will see a checkmark beside both entries to inform you that the new PIN has been accepted.

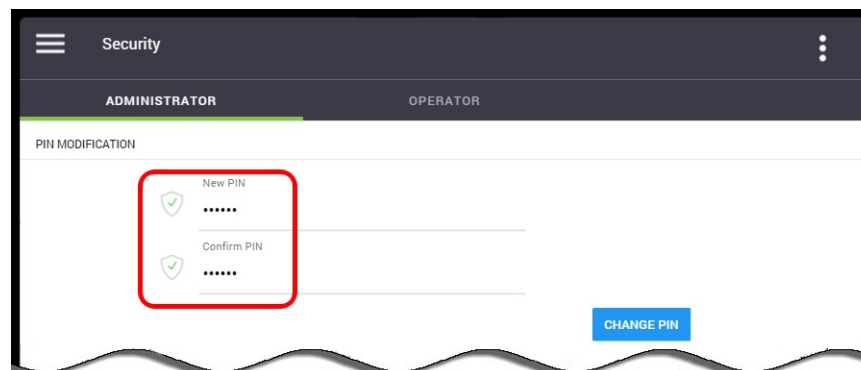

After entering their PIN on the main screen, the Administrator will have access to the menus for which the Operator gave them the necessary permissions. In most cases, this access will be limited and some options will not be available.

Setting the Carafe PIN

To set or change the PIN for the carafe, tap the “New PIN” field beside “Carafe PIN”, and follow the same procedure used to change the ‘Administrator’ PIN.

Note that the carafe PIN can only be 4 digits long.



Operator

The Operator can set or change their own PIN number in this tab, and can grant the necessary privileges (rights and access) to the Administrator.



The default pin for the Operator is '345678'. We recommend that you change this pin on the machine's initial set-up. **Store the new PIN information somewhere where it can easily be found (in your customer's file, for example)!**

1. Tap on '**Current Pin**' to open the numeric keypad.

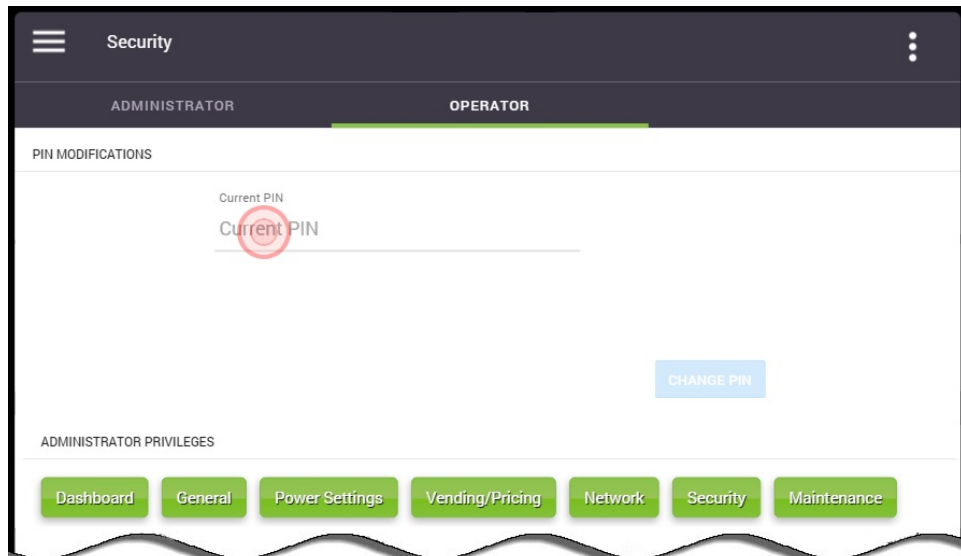

2. Using the keypad, enter your **current** PIN and then tap on '**Accept Change**'.

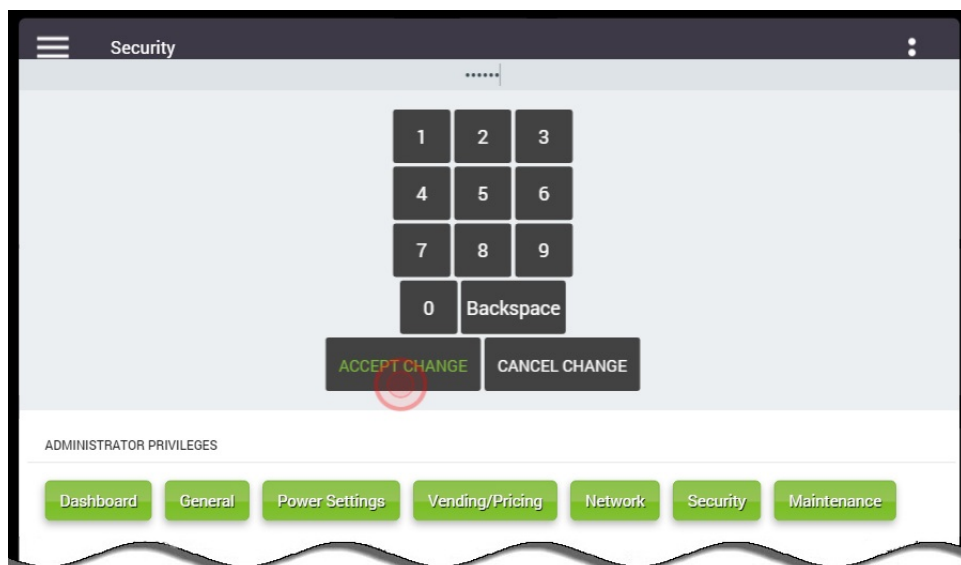

- Enter the new PIN you want to use **two times** - a checkmark appears beside the PINs if they were entered correctly. Once done, tap the “**Change Pin**” button to complete the change.

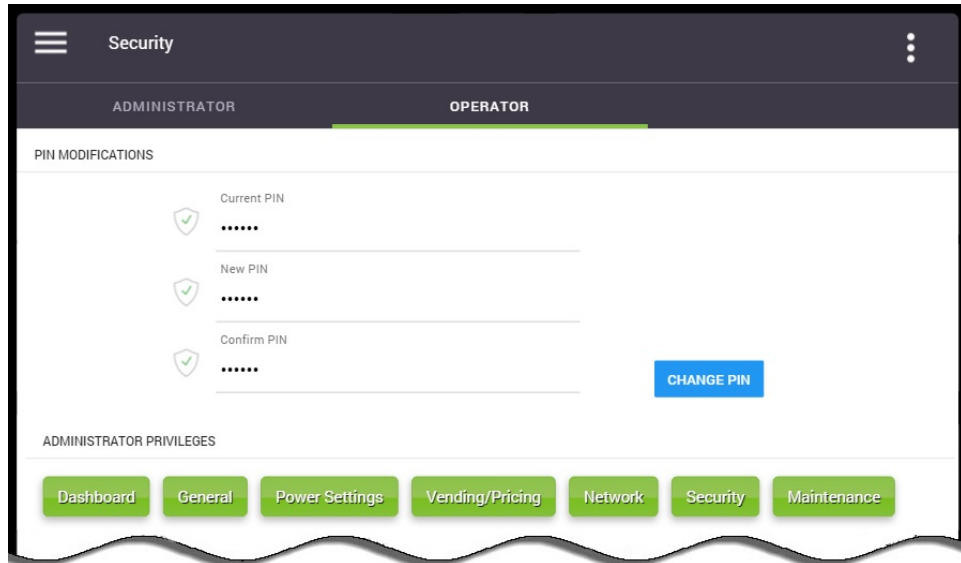

Administrator Privileges

- The lower portion of the screen shows the '**Administrator Privileges**'. By default, the Administrator is given access to all of the options (colored green).



- To change these options, tap on the options that you want to make available to the Administrator (they will change color to green). To remove the availability of any options, tap them so that they are grayed out.



In the screenshot above, in the '**Administrator Privileges**' section you'll now notice that the '**Dashboard**', '**General**', '**Power Settings**' and '**Maintenance**' options are green. These are the updated options available to the Administrator. The grayed-out options will not be visible to the Administrator.

Maintenance

Cleaning & Sanitizing Tab

This tab provides access to maintenance-related options. The “Standard Rinsing” options are simply automated quick-rinse cycles for the brewer and for the three whippers. The “Cleaning & Sanitizing” cycles require the use of special cleaning products, therefore user intervention is required.

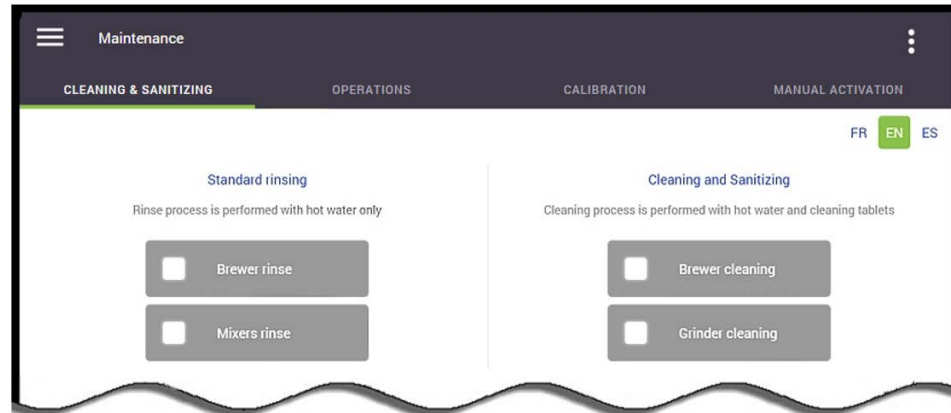

Standard Rinsing Section

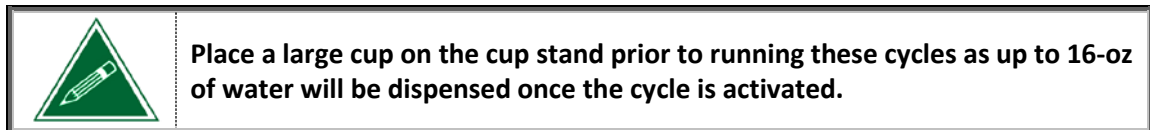

Brewer Rinse

The brewer rinse cycle dispenses water into the brewer as the piston repeatedly rises and lowers, creating agitation above and below the screen. This cycle is fully automated and does not require the use of any cleaning agents.

To manually run a brewer rinse cycle, tap the '**Brewer Rinse**' option.

Mixers Rinse

This cycle cleans all three of the powder whipper systems by sending hot water through each of the whipper units, while at the same time activating each of the whipper motors.

To manually run a powder rinse cycle, tap the '**Powder Rinse**'.

Cleaning & Sanitizing Section



Place a large cup on the cup stand prior to running these cycles as up to 16-oz of water will be dispensed once the cycle is activated.

Brewer Cleaning

The brewer cleaning cycle performs a thorough cleaning of the interior of the brewer, including the filter screen. This cycle is fully automated and requires the use of an **Urnex TABZ Z61** cleaning tablet and should be performed on a monthly basis, or more frequently if required.

To run a brewer cleaning cycle, tap the **'Brewer Cleaning'** option in the "Cleaning & Sanitizing" section of the screen and follow each of the steps that are displayed until the process is completed.

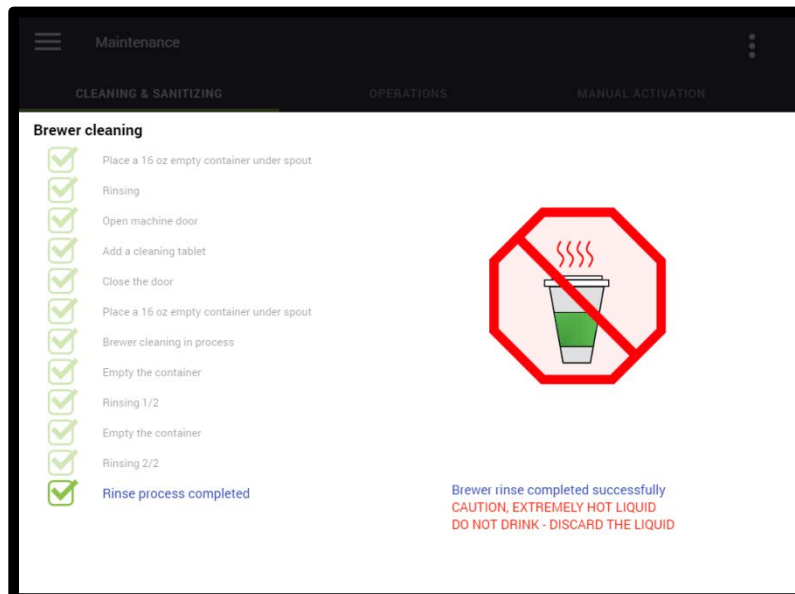
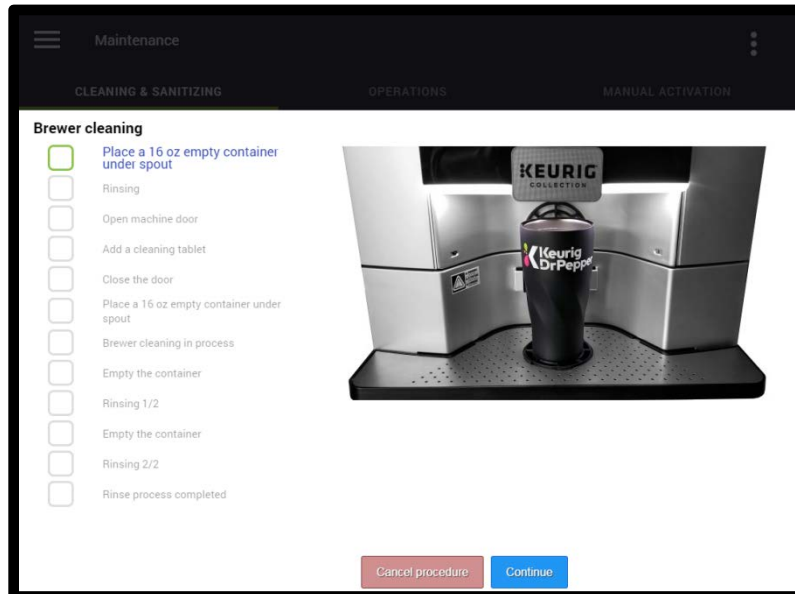

Grinder Cleaning

The grinder cleaning cycle removes coffee oils and buildup from the grinder heads (burrs). This cycle requires the use of a cap full of the **Urnex SuperGrindz A01** cleaning pellets (26 grams / 115 pellets), and should be performed on a monthly basis, or more frequently if required.

To run a grinder cleaning cycle, tap the **'Grinder Cleaning'** option in the "Cleaning & Sanitizing" section of the screen and follow each of the steps that are displayed until the process is completed.

Please note that this cycle is not fully automated as the coffee dispenser needs to be removed and re-installed as part of this process.

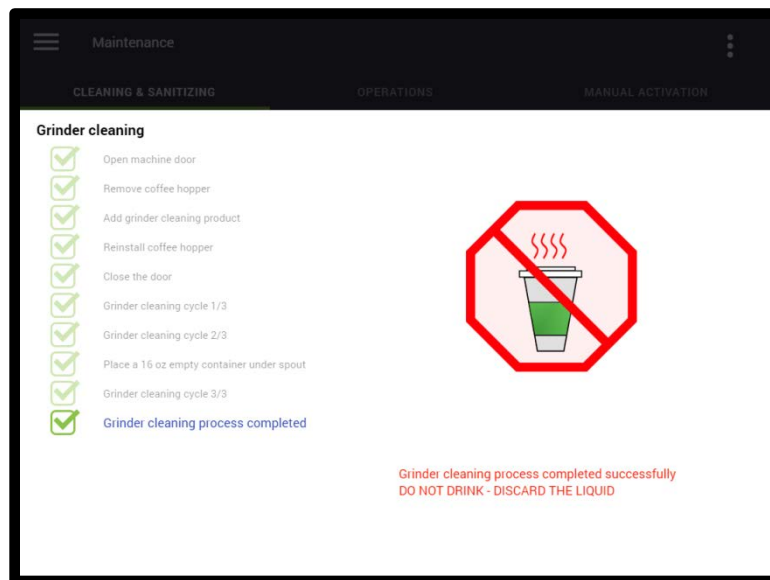
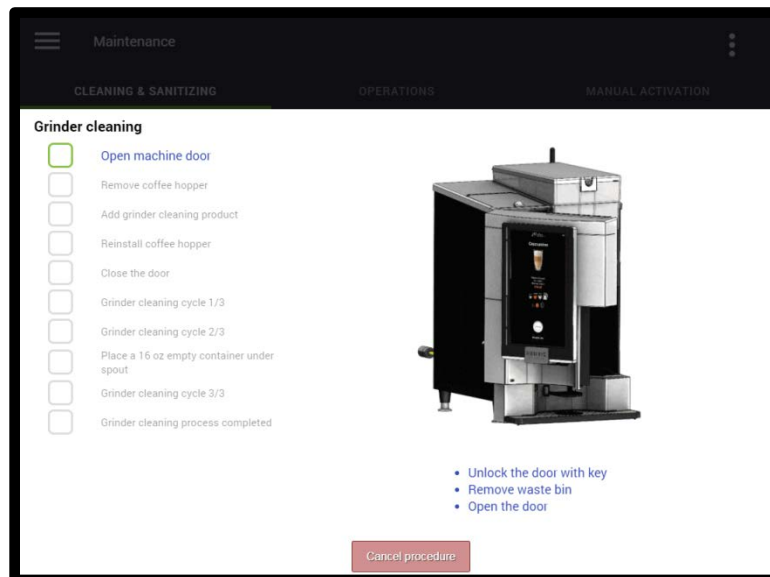

Operations Tab

This tab provides access to maintenance-related options.

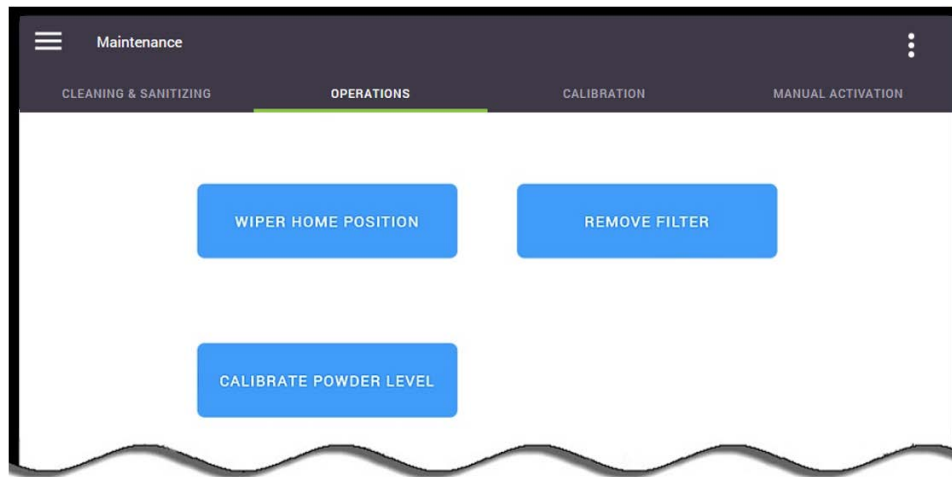

Wiper Home Position

This option reinitializes the brewer wiper to its home position (same procedure that occurs when the waste bin is removed and re-inserted).

Remove Filter

This option causes the brewer piston to cycle all the way to the bottom of the cylinder, which will "pop" (unclip) the filter screen from the piston. The piston then moves to the top of the cylinder so that the filter screen can be easily retrieved.

Calibrate Powder Level

This option automatically calibrates the powder motors and dispensers. Note that the machine comes pre-calibrated from the factory, therefore running this cycle is not necessary. Should you replace one of the powder motors or one of the powder dispensers, we recommend that you execute this calibration cycle.



This cycle must be executed with empty powder dispenser(s). Do not run this cycle if there is product in the powder dispenser(s) as the calibration will not be accurate and the whipper bowls will fill with powder.

After the cycle is finished, it takes several vends for the dispenser(s) to properly complete their calibration. The machine can be used normally throughout this brief period.

Calibration

The Calibration menu allows you to calibrate the coffee gram throws (individually for all coffee dispensers) and to calibrate the low powder detection level.

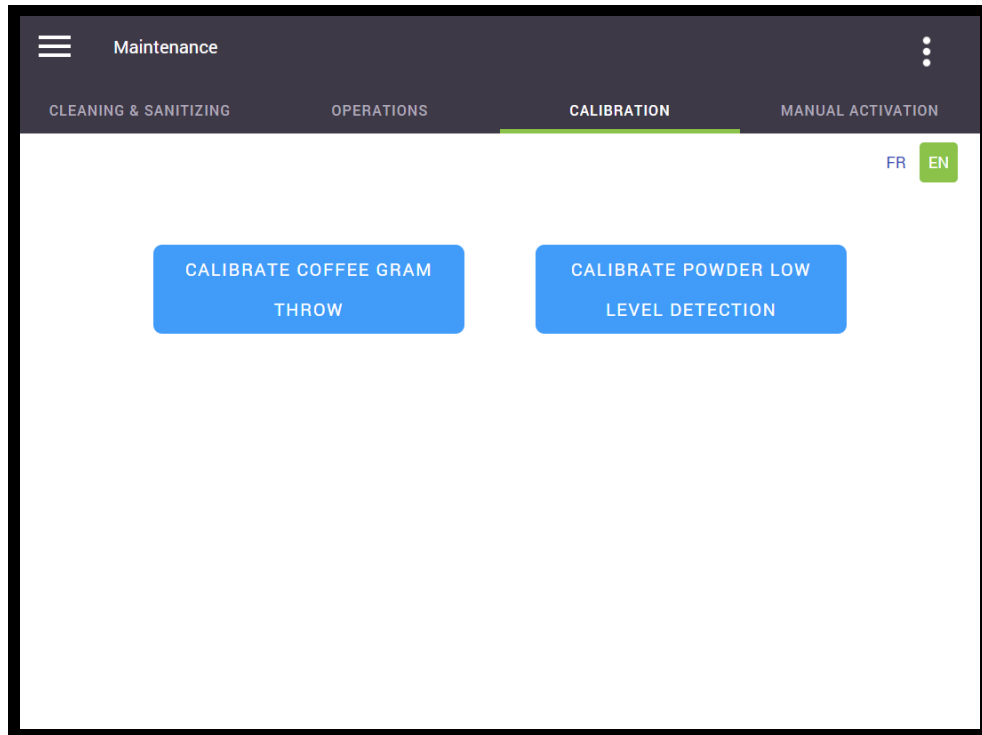

Calibrate Coffee Gram Throw

1. Select the coffee dispenser to be calibrated.

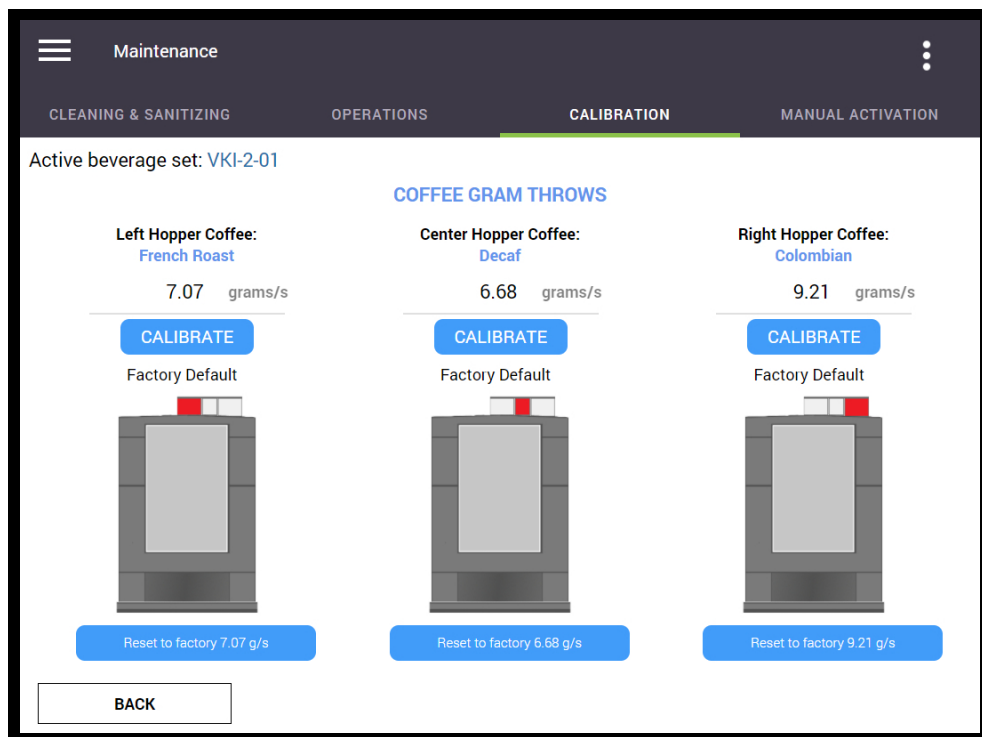

- Follow the prompts and step-by-step instructions that are displayed on the screen.

The screenshot shows a mobile application interface for a coffee machine. At the top, there is a 'Maintenance' header with a menu icon on the left and a three-dot menu on the right. Below the header are four tabs: 'CLEANING & SANITIZING', 'OPERATIONS', 'CALIBRATION' (which is highlighted with a green underline), and 'MANUAL ACTIVATION'. The main content area is titled 'CALIBRATING LEFT HOPPER WITH "FRENCH ROAST" COFFEE'. Underneath this title is the word 'INSTRUCTIONS' followed by a numbered list of 9 steps. To the left of the instructions is a small image of a coffee machine hopper. At the bottom of the screen, there are two buttons: a blue 'SETUP DONE' button and a white 'BACK' button.

Maintenance

CLEANING & SANITIZING OPERATIONS **CALIBRATION** MANUAL ACTIVATION

CALIBRATING LEFT HOPPER WITH "FRENCH ROAST" COFFEE

INSTRUCTIONS

1. Make sure you have **AT LEAST 2 LB** of French Roast coffee in the left hopper.
2. Make sure you have your **SCALE**, a small tray and a 12 oz paper cup ready.
3. Remove the waste bin and open the door.
4. Press on the "**SETUP DONE**" button.
5. Place the empty cup on the scale and tare (zero) the scale.
6. Place the tray under the grinder chute.
7. Press on "**EMPTY**" button to prime the grinder and discard the contains.
8. Place the tray under the grinder chute prior to each of the next 3 steps.
9. Press on the "**START 1/3**", then empty the contains from the tray into the cup on scale.

SETUP DONE

BACK

- Touch 'Setup Done' once complete to return to the main Calibration screen.
- Repeat for the other coffee dispenser(s) if required.

Calibrate Powder Low Level Detection

This option automatically calibrates the powder motors and dispensers to detect when the powder lever is too low and requires refilling. Note that the machine comes pre-calibrated from the factory, therefore running this cycle is not necessary. Should you replace one of the powder motors or one of the powder dispensers, we recommend that you execute this calibration cycle.





This cycle must be executed with empty powder dispenser(s). Do not run this cycle if there is product in the powder dispenser(s) as the calibration will not be accurate and the whipper bowls will fill with powder.

After the cycle is finished, it takes several vends for the dispenser(s) to properly complete their calibration. The machine can be used normally throughout this brief period.

Manual Activation

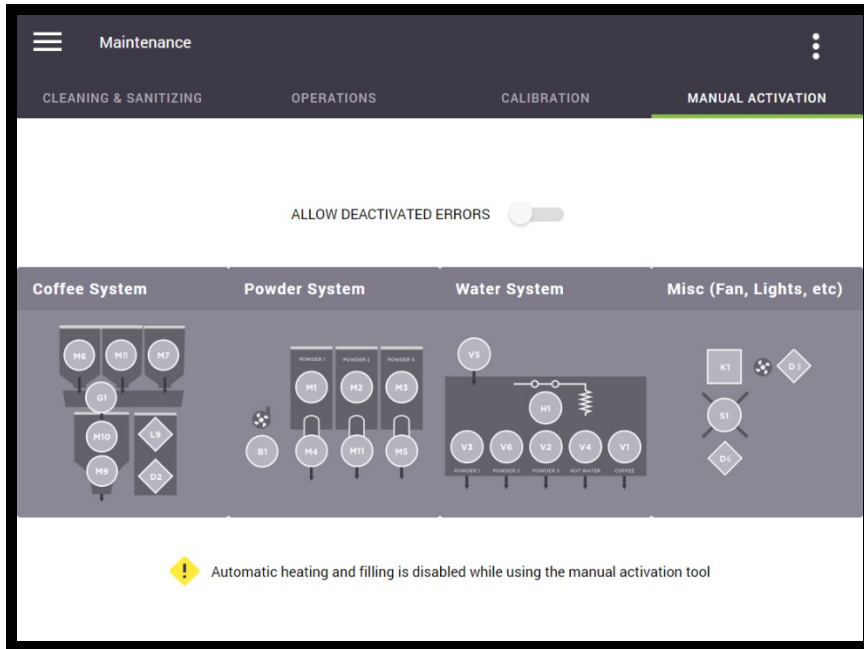
The Manual Activation screen allows you to test individual components to ensure they are functioning properly. The main screen outlines all of the systems within the Momentum™. Once the main system is selected, any of the components within this system can then be selected.





When testing components in this menu, note that only one component will activate at any given time. This is extremely important to remember when testing coffee or powder dispenser motors, as well as outlet valves.

Coffee System

In the following example, the component to be tested is the **bean grinder**. First, select the main system, which in this case is the “Coffee System”.

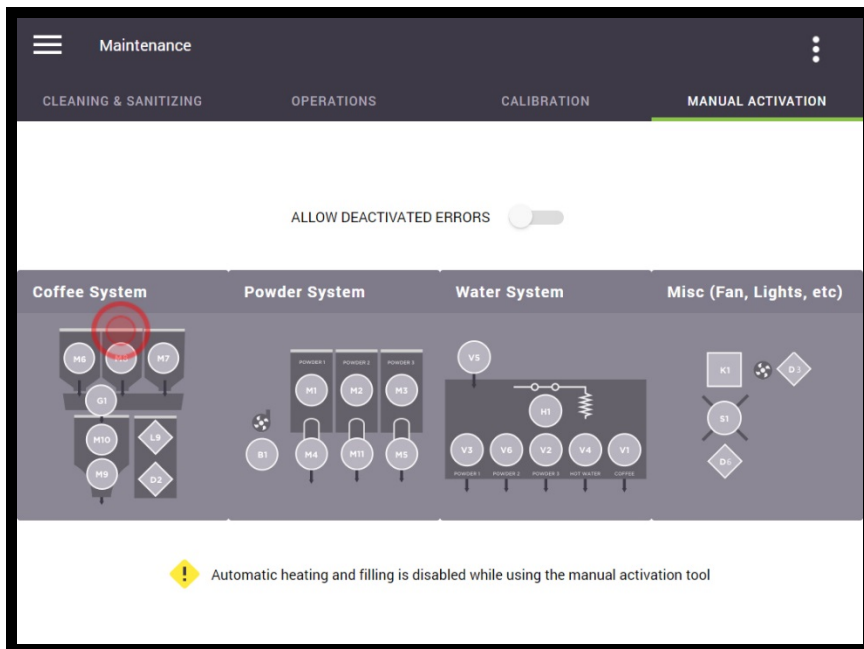

A new screen now appears showing all of the components that are part of the Coffee System. Each component is identified by a unique component code.

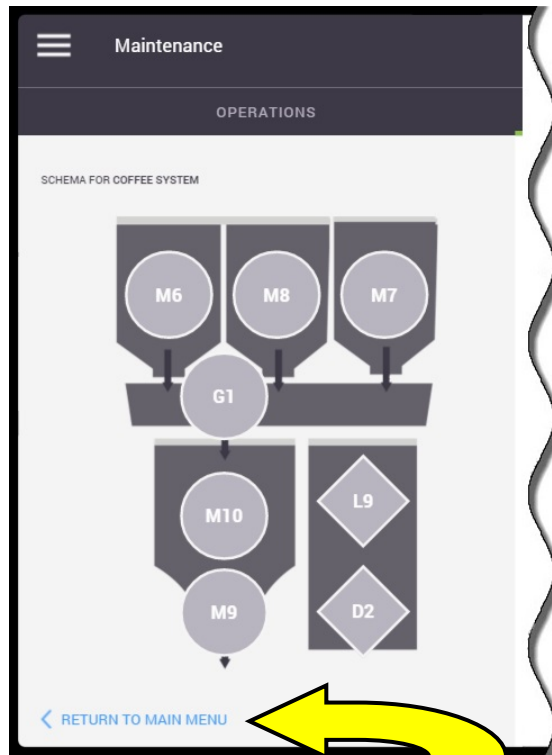

CODE	COMPONENT
D2	Waste Bin Presence Detection
G1	Grinder
L9	Waste Bin Full Sensor
M6	Coffee 1 Motor
M7	Coffee 2 Motor
M8	Coffee 3 Motor
M9	Brewer Motor
M10	Brewer Wiper Motor



You can select the “Return to Main Menu” option at the lower left of the screen at any time to return to the main Engineering menu.

Select the component to be tested by tapping on it on the screen (in this example, the component is the grinder – G1).

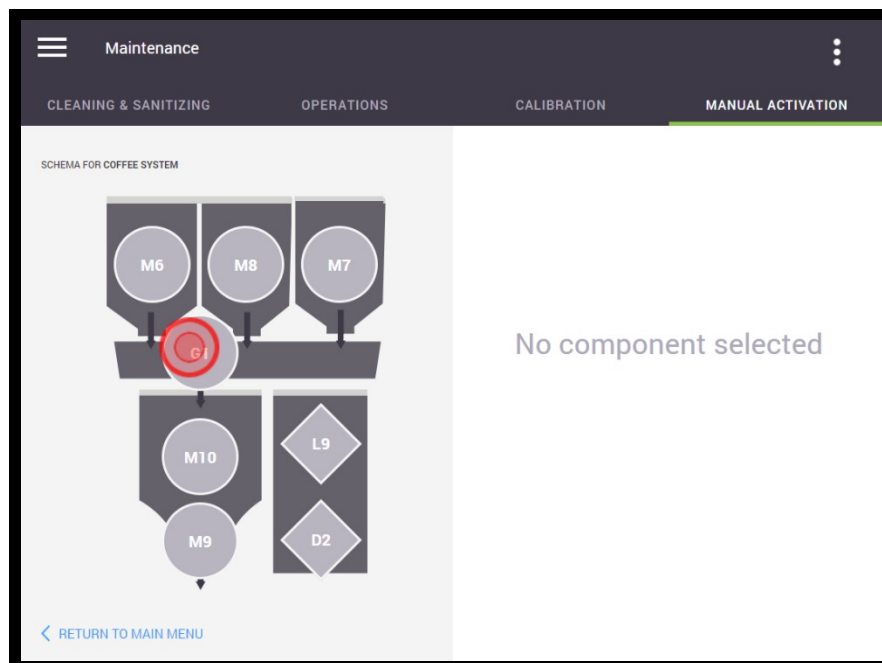

The testing options now appear on the right section of the screen. In this example, the only option available is to activate the grinder for 3 seconds.

Tap the “Activate” button and the grinder (**only**) will energize for 3 seconds.

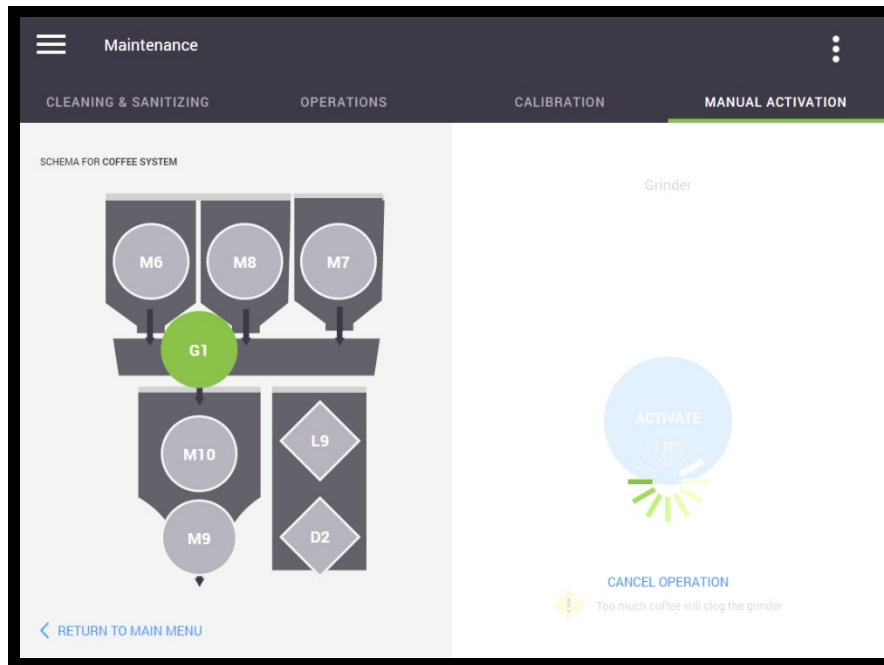
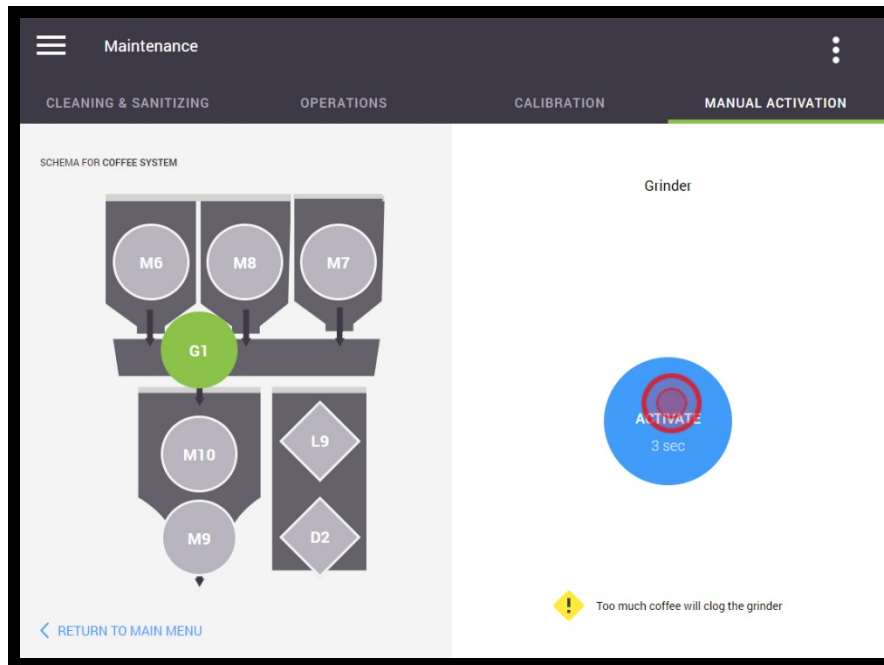

It is extremely important to note that when testing the coffee motors (M6, M7 or M8), **ONLY** the coffee motor will activate. Coffee beans will be dispensed into the grinder but the grinder, or any other component, will **NOT** activate.



When testing the Waste Bin Presence (D2) or Waste Bin Full (L9) sensors, a voltage level and the bin’s status (present or absent) are displayed on the screen.

Powder System

If the Powder System is selected from the main Engineering screen, the following component options appear for testing:

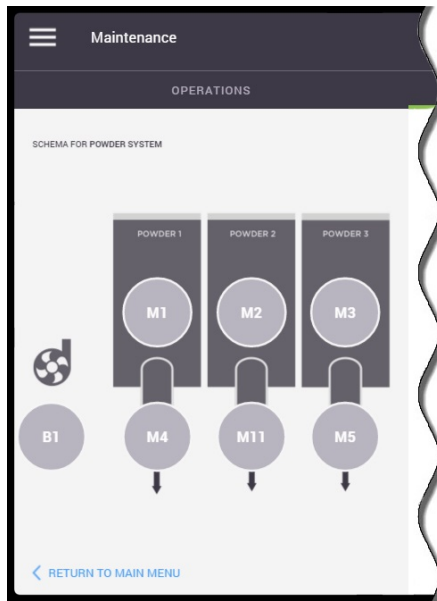

CODE	COMPONENT
B1	Blower (Powders)
M1	Powder 1 Motor
M2	Powder 2 Motor
M3	Powder 3 Motor
M4	Powder 1 Whipper Motor
M5	Powder 3 Whipper Motor
M11	Powder 2 Whipper Motor



It is extremely important to note that when testing the powder motors (M1, M2 or M3), ONLY the powder motor will activate. Powder will be dispensed into the whipper but the whipper motor and powder valve, will NOT activate.

Water System

If the Water System is selected from the main Engineering screen, the following component options appear for testing:

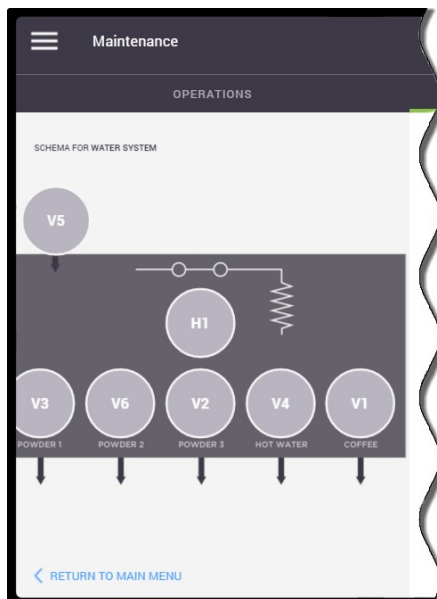

CODE	COMPONENT
H1	Heating Element
V1	Coffee Valve
V2	Powder 3 Valve
V3	Powder 1 Valve
V4	Hot Water Valve
V5	Inlet Valve
V6	Powder 2 Valve



CAUTION: Extremely hot water will be dispensed when testing any of the outlet valves! Please note that the coffee valve (V1) will dispense water directly into the brewer, but the brewer will not activate.

Miscellaneous Components

If Miscellaneous is selected from the main Engineering screen, the following component options appear for testing:

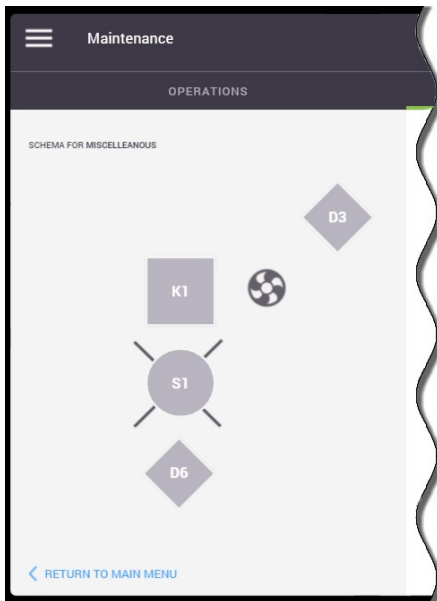

CODE	COMPONENT
D3	Door Open Detection
D6	Cup Detection
K1	Exhaust Fan
S1	Cup Lighting

Multimedia

The Multimedia screen is used to configure the images or the videos that are played when a specific beverage is being prepared. Each beverage can be configured independently, if you so choose.

System Default

With this option selected, the factory pre-set default images and videos will be used during the beverage preparation process.

Follow Beverage Set

With this option selected, the pre-set 'Beverage Set' images and videos that are associated with the active beverage set (if applicable) will be used during the beverage preparation process.

User

With the 'User' option, you can select an image or video to play as a screensaver or to play when a specific beverage is being prepared. Each beverage can be configured independently, if you so choose.

To associate an image or a video to a specific beverage, or to set the screensaver:

1. Select the desired beverage.

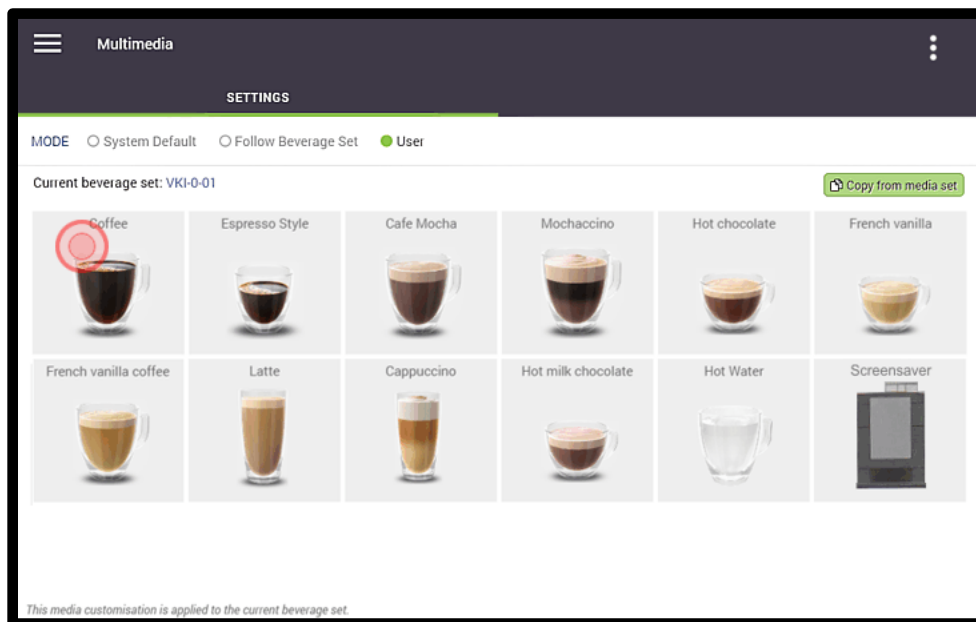

- From the list, select the video you wish to play during the preparation of the selected beverage.

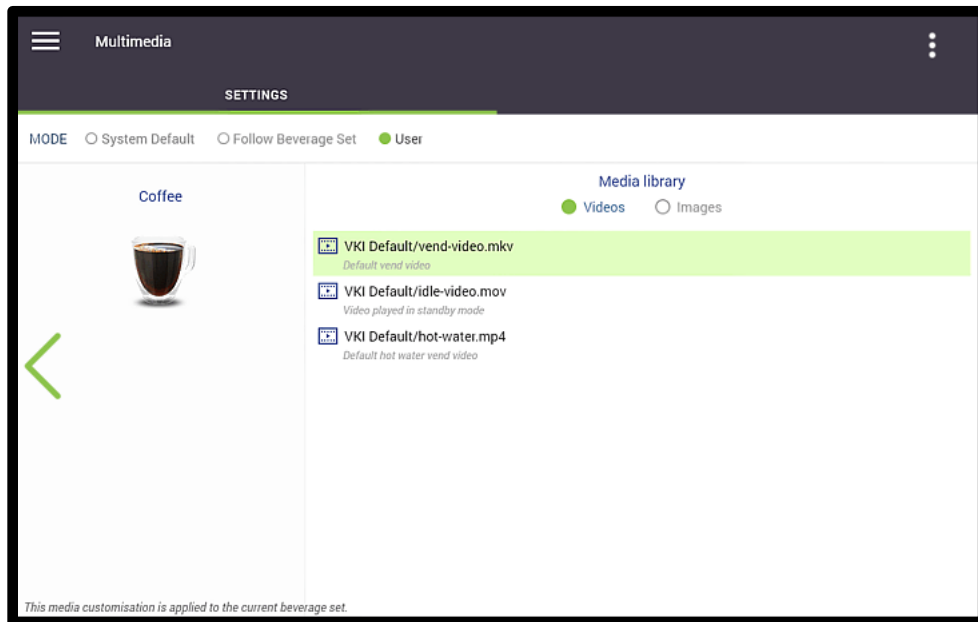

- To select an image instead of a video, tap on the “Image” button and select the desired image from the list.

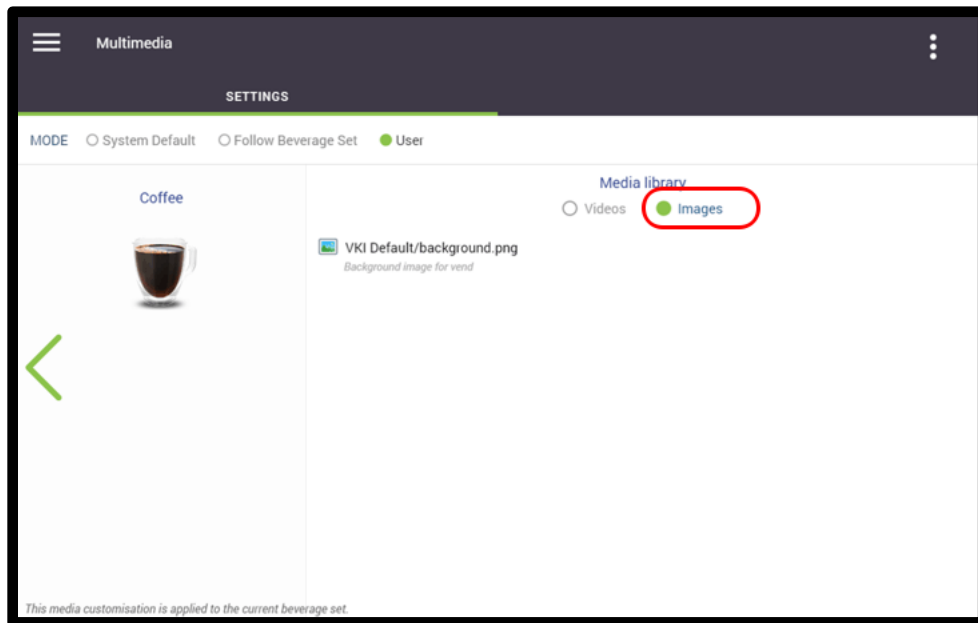

 **If you have loaded custom videos or images that were created for you by VKI, they will be integrated into the Media Library and they will appear on the list(s) in steps #2 and #3 above.**

Copy from Media Set

This option allows you to globally set the images and videos that appear during the beverage preparation process. It is normally set to use the 'VKI Default' media. However, if you have loaded any custom media, you can switch to it using this option.

1. Tap the 'Copy from Media Set' button on the top right of the screen.

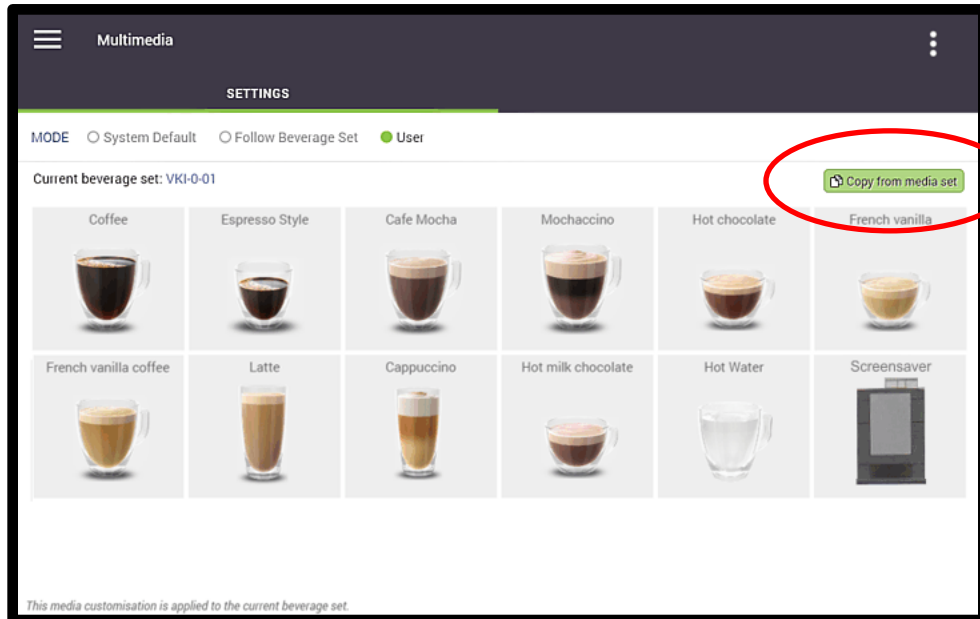

2. From the list that appears, select the option you require.
 - a. If you have loaded custom media into the machine, select the '**Custom**' option.
 - b. If you want to display the factory pre-loaded media, select the '**VKI Default**' option.

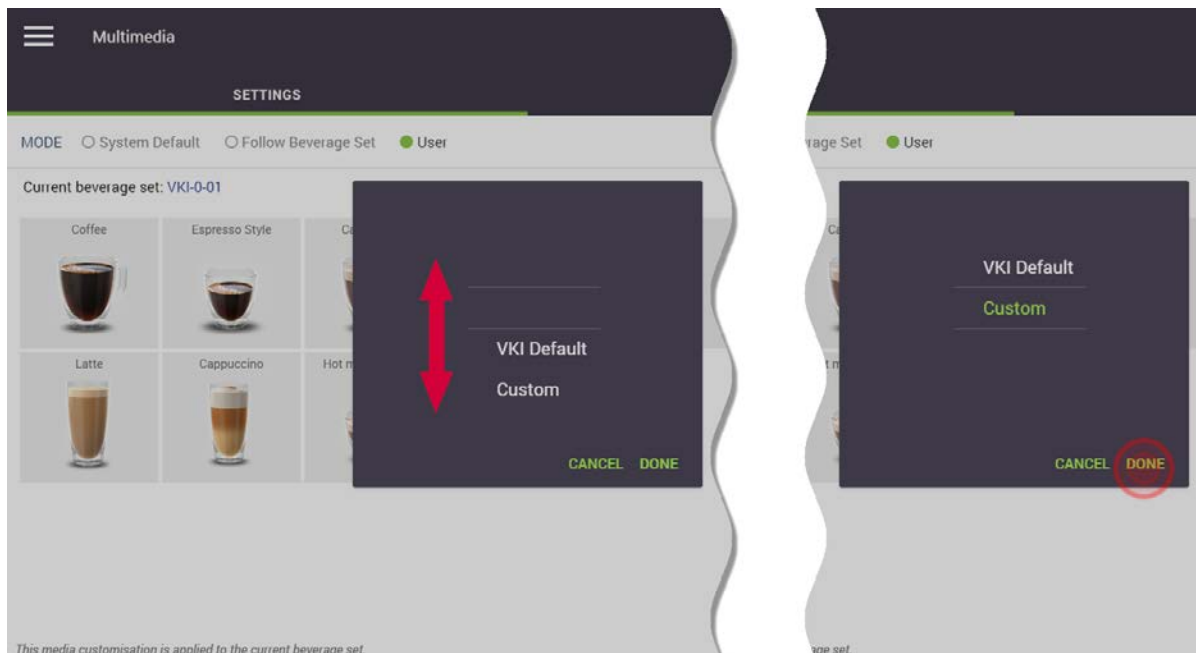

3. Tap '**Done**' and the media set that was selected will then be loaded into the machine.

Requesting Custom Images or Videos

To place an order for your custom image and/or video file, you need to send your image/video file (meeting the criteria outlined below) to tech.support@kdrp.com. We will configure the necessary files package that will enable you to load your custom image and/or video into the machine and we will provide you with a download link to access it.

Multimedia Specifications

The images or videos that appear during the beverage preparation process must meet the following specifications:

Images:

Format:	.PNG Non-interlaced, sRGB, 8 bits per pixel
File Name:	The file must be named as you want it to appear in the Multimedia menu.
Dimensions:	1080 pixels x 1920 pixels
Note:	The progress bar occupies the bottom 22 pixels of the screen.

Videos:

Format:	.MKV
File Name:	The file must be named as you want it to appear in the Multimedia menu.
Encoding:	H.264
Resolution:	720 x 1280
Frame Rate:	24 FPS
Audio:	These must be no audio on the video.
Note:	The progress bar occupies the bottom 80 pixels of the screen.

Once you have downloaded the .ZIP file from the link that was sent to you:

1. Double-click the .ZIP file to open it.
2. Copy the contents on the .ZIP file directly onto a blank USB flash drive.
3. Insert the USB flash drive into the USB port on your machine and reboot the machine using the power switch.
4. The files will automatically load into the machine. Once done, you will be prompted to remove the USB flash drive, at which point the machine will reboot itself automatically and the files will be loaded.
5. Configure your media settings as outlined earlier in this Multimedia section of the manual.

SECTION 4

Care and Maintenance

To keep the Eccellenza Momentum™ running efficiently and at peak performance, the following maintenance procedures must be performed at their specified intervals. It is recommended that equipment maintenance be scheduled at a time that would be the least disruptive to your customers. Whenever possible, replace the components requiring maintenance with new or refurbished ones, and then refurbish the older components at your shop.



Failure to perform the required care and maintenance will result in poor beverage quality and will lead to equipment malfunctions. It may also void any remaining warranty on the equipment and its components.

Daily Care

- ▶ **Empty the Cup Stand** – empty the contents of the cup stand and rinse the stand and grill under clean running water.
- ▶ **Empty the Waste Bin** – empty the contents of the waste bin.
- ▶ **Refill the Coffee Dispensers and Powder Dispensers** – top off the coffee and powder dispensers. **Do not pack the products into the dispensers!**
- ▶ **Wipe Exterior and Countertop** – using a clean towel, wipe any coffee grounds and spills from the exterior of the machine, and from the countertop on which it sits.

Every 1-2 Weeks

- ▶ **Clean the whipper components** - for detailed information about disassembling and cleaning the whipper components, consult the Momentum™ Service Manual (VKI Publication #202378-001).
- ▶ **Inspect Water Hoses and Tubing** - inspect all plumbing connections, water hoses, tubing, clamps, fittings and water related components (valves, water tank, etc.) for signs of wear or damage. Replace them, if required.

Every 15,000 Cycles or 12 Months

- ▶ **Inspect Electrical Wiring and Components** - inspect all of the equipment wiring, terminals, connectors and electrical components (valves, motors, relays, element, etc.) for signs of wear, damage or overheating at connection points. Replace them, if required.
- ▶ **Clean the whipper hoses** - remove all three whipper outlet hoses and thoroughly clean the exterior and the interior of each of the hoses. A plastic bristled brush must be used to clean the interior of the hoses.



- ▶ **Replace whipper seals** - replace the rubber seals on all three whipper bases.

- **Replace Brewer Seals and Gaskets** - *there are several seals and gaskets located throughout the brewer assembly that need to be replaced every 12 months or 15,000 cycles. The brewer 'Yearly Maintenance Kit' contains everything required.*

1-Year Brewer Maintenance Kit / Kit d'entretien pour l'infuseur, 1-an

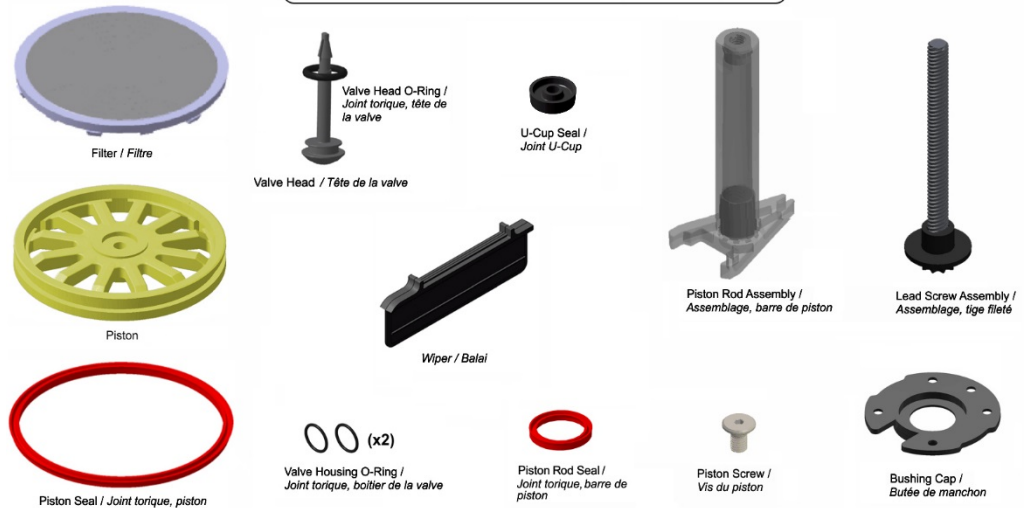

- **Clean the remaining brewer components** with warm water.

Every 3 Years

- **Replace the following:** *heater element, thermal cut-off switch, all seals and gaskets and o-rings.*

Miscellaneous

- Run the **Brewer Rinse and/or Powder Rinse Cycles** when prompted by the machine (a message appears on the touch screen).
- Run the **Brewer Cleaning** cycle using the Urnex TABZ Z61 cleaning tablets – see [page 93](#).
- Run the **Grinder Cleaning** cycle using the Urnex SuperGrindz A01 cleaning pellets – see [page 93](#).
- **Verify Water Tank Components** - *dependant on the local water conditions, inspect, clean or replace components, as required.*
- **Clean the Side Exhaust Fan** - *over time, dust will accumulate on the exhaust fan on the right side wall and it must be cleaned to maintain the fan's performance.*
- **Cleaning the Coffee Dispenser** - *empty, remove, and clean the coffee dispenser with warm water and dish soap. Thoroughly dry the dispenser before re-installing it. For detailed information about removing the coffee dispenser, consult the Momentum™ Service Manual (VKI Publication #202378-001).*
- **Cleaning the Powder Dispensers** - *empty, remove, and clean the powder dispensers with warm water and dish soap. Thoroughly dry the dispensers before re-installing them. For detailed information about removing the powder dispensers, consult the Momentum™ Service Manual (VKI Publication #202378-001).*
- **Inspect the grinder** – to prevent the grinder from jamming, re-adjust the grinder heads if the coffee grounds are too fine, and keep the grinder chute clean.



Failure to perform the required care and maintenance will result in poor beverage quality and will lead to equipment malfunctions. It may also void any remaining warranty on the equipment and its components.

SECTION 5

Error and Reminder Messages

Main Screen

Message Displayed	Condition	Action(s) Required
Backend Services Unreachable. Trying to reconnect...	The connection was lost.	Will reconnect automatically. If not, reboot the machine.
<ul style="list-style-type: none"> • System Starting • Waiting for initialization • System initialization • System update • Warming up • Machine warming up • System Ready • Brewing in progress • Water filling • Brewer reinitialization 	These are all regular operation messages.	These messages will clear themselves automatically.
Power Saving Mode	The machine is currently in Power Saving mode.	The machine will exit Power Saving mode at its preset wake time.
Powder #1 (#2, #3) low level. Fill powder container #1 (#2, #3)	The powder level for the identified container (#1, #2 or #3) is low.	Refill the powder container(s). <i>Note: the message may continue to appear for a few vends after refilling - this is normal and it will clear.</i>
Empty waste bin and cup stand	The waste bin is full.	Empty the contents of both the waste bin and the cup stand.
Automatic brewer (or powder system) rinse. Insert an empty container under spout and press <Start>.	The automatic rinse cycle for the brewer or for the powder system has been triggered.	Place an empty, leak proof container under the pour spouts area, and then press <Start> to begin the rinse cycle.
Overflow detected. Remove and empty cup stand and floor tray.	An overflow has been detected.	Remove the cup stand and floor tray and empty their contents.
Verify water connection and feed	The water tank is taking too long to fill.	Check the main water source, as well as the hoses going to the machine inlet valve for leaks or blockages.
Please reinsert waste bin	The waste bin is not installed.	Install the waste bin. If message persists, check the waste bin sensor. *If message persists, clean the proximity sensor and the brewer wiper.
Water Safety Level. Water level has reached the level safety probes.	The water tank has overfilled.	Drain some water from the tank. If this persists, clean the level probes.
Interrupted vend. Insert an empty container under spout and press Start.	The vend was interrupted and the cycle did not finish.	Place a cup under the pour spouts and press the <Start> button. Any liquid still in the system will drain into the cup. NOTE: If Step 2 of 2 cannot be activated, go to "System Status" menu and clear any errors that are present.
Call for Service (in VENDING MODE)	The Cashbox is full.	Empty the cashbox and reset the cashbox counter.

System Status Screen

Code	Message Displayed	Condition	Action(s) Required
--	Electronic Board Communication Lost Please Call for Service or Press Acknowledge to Retry	Communication between the control board and HMI is lost.	1 - Press "Acknowledge" to reset 2 - Reboot the machine. 3 - If message persists, check the HMI, Control Board and wiring.
B1	Blower & Fan current is over safety level	Blower & Fan current is above the recommended safety level. Fan may be drawing too much power.	1 - Check wiring and connections for the powder system blower. 2 - Clean the blower. 3 - If it persists, replace blower.
	Blower & Fan current is under minimum operation level	Blower & Fan current is below the minimum operating level. Fan may not be drawing enough power.	1 - Check wiring and connections for the powder system blower. 2 - If message persists, replace the powder system blower.
D1	Tank Overflow Detection	The water tank has overflowed.	Clean the overflow. If problem persists, check the following: 1 - Machine may have been moved. 2 - If it overflows with the power off, replace the inlet valve. 3 - May be boiling – lower the tank temperature or replace thermistor. 4 - Descale tank components.
D2	LED in Waste Bin detector has a fault	The IR LED of the waste bin sensor voltage is over the configured maximum operation level.	1 - Clear the message. 2 - Excute the manuel test from the Maintenence menu. 3 - Clean the sensor. 4 - Reboot the machine. 5 - Check wiring and connectios 6 - If message persists, replace the waste bin presence sensor.
D3	Machine's door is open.	The front door of the machine is open.	1 - Close the front door. 2 - If message persists, check or replace the front door sensor.
D6	Cup is present in dispensing area.	A cup has been detected in the dispensing area.	If no cup is present, clean the cup detection LEDs.
G1	Coffee Grinder Over Current Standby	The grinder current was over the stand by operation level.	1 - Clear the message. 2 - Reboot the machine.
	Grinder Fuse Fault	Grinder fuse has triggered a fault.	1 - Clear the message. 2 - Reboot the machine. 3 - Grinder may be jammed. Unclog the chute, clear the jam and then clear the error. 4 - Grinder blades may need adjustment. 5 - Check fuse on the control board. 6 - Grinder may be damaged – replace the grinder.
	Grinder's current is close to critical level	Grinder current is close to maximum operating level. Grinder may be drawing too much power.	1 - Check to see if the grinder is jammed (possibly a foreign object in the grinder heads). 2 - Check blade adjustment (0.017") 3 - Reboot the machine. 4 - If it persists, replace grinder.
	Grinder's current is close to minimum operation level	Grinder current is close to minimum operating level. Grinder may not be drawing enough power.	1 - Reboot the machine. 2 - If it persists, replace the grinder.
	Grinder's current is over safety level	Grinder current has exceeded the maximum operating level.	1 - Check to see if the grinder is jammed (possibly a foreign object in the grinder heads). 2 - Check blade adjustment (0.017") 3 - Reboot the machine. 4 - Replace the grinder.
	Grinder's current is under minimum operation level	Grinder current is below the minimum operating level.	1 - Check condition of grinder belt. 2 - Check wiring and connections to the grinder. 3 - Replace the grinder.

Code	Message Displayed	Condition	Action(s) Required
H1	Heater's current is close to critical level	Heater current is close to maximum operating level. Heater may be drawing too much power.	<ol style="list-style-type: none"> 1 - Inspect wiring and connections to the heater relay and heater element. 2 - Heater element may be drawing too much power. Ensure resistance of the element is 7.8Ω to 9.3Ω. 3 - If message persists, replace the heater element.
	Heater's current is close to minimum operation level	Heater current is close to minimum operating level. Heater may not be drawing enough power.	<ol style="list-style-type: none"> 1 - Reboot the machine. 2 - Ensure resistance of the heater element is 7.8Ω to 9.3Ω. 3 - Check voltage at heater element (should be 120VAC when heating). 4 - Check the continuity of the thermal cut-off on the heater relay. 5 - If message persists, replace the heater element.
	Heater's current is over safety level	Heater current has exceeded the maximum operating level.	<ol style="list-style-type: none"> 1 - Inspect wiring and connections to the heater relay and heater element. 2 - Ensure resistance of the heater element is 7.8Ω to 9.3Ω. If not, heater element may need to be replaced. 3 - Heater relay may need to be replaced.
	Heater's current is under minimum operation level	Heater current is below the minimum operating level.	<ol style="list-style-type: none"> 1 - Check wiring and connections to the heater relay. 2 - Check the continuity of the thermal cut-off on the relay. If open, heater relay kit must be replaced. 3 - Check wiring and connections to the heater element. 4 - Replace heater element.
	Water Tank Default Critical Min Temp	Water temperature went below the configured minimum critical temperature (Default 0 C).	<ol style="list-style-type: none"> 1 - Clear the message. 2 - Reboot the machine. 3 - Check the range of the resistance of the temp probe.
	Water Tank Default Fill Heating Time	Inlet valve and heater were both activated for a period of time longer than the configured timeout.	<ol style="list-style-type: none"> 1 - Clear the message. 2 - Reboot the machine.
	Water Tank Heating Timeout	Reaching the water set point (Default 95°C) took longer than the maximum configured heating timeout (Default: 30 min.)	<ol style="list-style-type: none"> 1 - Clear the message. 2 - Reboot the machine. 3 - Check the range of the resistance of the temp probe. 4 - If message persists, replace the heater element.
	Water Tank Heating Probe Error	Heater bad connection count has exceeded the configured limit.	<ol style="list-style-type: none"> 1 - Clear the message. 2 - Reboot the machine.
	Water temperature is over the maximum level	Water temperature has exceeded configured temperature setting.	<ol style="list-style-type: none"> 1 - Check the range of the resistance of the temp probe. 2 - Heater relay may need to be replaced. 3 - Control board may need to be replaced.

Code	Message Displayed	Condition	Action(s) Required
K1	Fan is not present or has abnormal operation	Fan is not present or operating abnormally.	<ol style="list-style-type: none"> 1 - Check fan wiring and connection to the control board. 2 - Make sure that the software version is 2.6.3 or higher. 3 - Clean any accumulation from fan. 4 - If message persists, replace the exhaust fan. 5 - If message persists, replace the control board.
L4	Water Tank Level Error	Safety level probe is detected while the normal level probe is not.	<ol style="list-style-type: none"> 1 - Check wiring and connections to the level probes (cross connection). 2 - Clean level probes.
L5	The water level is reaching the safety level probes	The water tank has overfilled and the water level is reaching the safety level probe.	<ol style="list-style-type: none"> 1 - If this occurs during initial heating, it may be due to water expansion. Empty some water from tank. 2 - The machine may have been moved causing tank to overfill. Empty some water from tank. 3 - Level probes require cleaning.
L9	Waste Bin Level Sensor	Sensor is open or shorted.	<ol style="list-style-type: none"> 1 – Make sure there is nothing obstructing the sensor. 2 - Do the manual test from the maintenance menu - it should show 500 to 600mV = empty, 650mV to 2500mV = full
MDB1	Cash Box Full	The cash box in the changer housing is full.	<ol style="list-style-type: none"> 1 – Empty the cash box. 2 – Reset the Cash Box counter.
	Coin Changer...(various messages)	Miscellaneous Coin Changer-related issues.	Consult the coin changer manufacturer's documentation.
MDB3	Card Reader...(various messages)	Miscellaneous Card Reader-related issues	Consult the card reader manufacturer's documentation.
M1, M2, M3	Powder Dispensers current is close to critical level	Powder Dispenser current is close to maximum operating level. Powder motor may be drawing too much power.	<ol style="list-style-type: none"> 1 - The powder product in the dispenser may be packed or compressed. Empty the dispenser. 2 - The dispenser may be jammed. 3 - The dispenser motor may be seized. Try to unseize the motor. 4 - If message persists, replace the powder dispenser motor.
	Powder Dispensers current is close to minimum operation level	Powder Dispenser current is close to minimum operating level. Powder motor may not be drawing enough power.	<ol style="list-style-type: none"> 1 - Check the wiring and connections to the powder dispenser motor. 2 - The powder dispenser may not be engaged properly with the powder dispenser motor. 3 - The powder dispenser motor coupling may need to be replaced. 4 - If message persists, replace the powder dispenser motor.
	Powder Dispensers current is over safety level	Powder Dispenser current has exceeded the maximum operating level.	<ol style="list-style-type: none"> 1 - The powder in the dispenser may be packed or compressed. Empty the powder dispenser. 2 - Powder dispenser may be jammed. 3 - The powder dispenser motor may be seized. Try to free the motor. 4 - If message persists, replace the powder dispenser motor.
	Powder Dispensers current is under minimum operation level	Powder Dispenser current is below the minimum operating level.	<ol style="list-style-type: none"> 1 - Check the wiring and connections to the powder dispenser motor. 2 - If message persists, replace the powder dispenser motor.

Code	Message Displayed	Condition	Action(s) Required
M4, M5, M11	Whippers current is close to critical level	Powder Whipper current is close to maximum operating level.	<ol style="list-style-type: none"> 1 - Check for clogging in the mixing bowls. 2 - Make sure the Impellers are properly installed and not touching the mixing bowls. 3 - If message persists, replace the faulty whipper motor.
	Whippers current is close to minimum operation level	Powder Whipper current is close to minimum operating level.	<ol style="list-style-type: none"> 1 - Check wiring and connections to the whipper motor. 2 - If message persists, replace the faulty whipper motor.
	Whippers current is over safety level	Powder Whipper current has exceeded the maximum operating level.	<ol style="list-style-type: none"> 1 - Check for clogging in the mixing bowls. 2 - Make sure the Impellers are properly installed and not touching the mixing bowls. 3 - If message persists, replace the faulty whipper motor
	Whippers current is under minimum operation level	Powder Whipper current is below the minimum operating level.	<ol style="list-style-type: none"> 1 - Check the wiring and connections to the whipper motor. 2 - If message persists, replace the faulty whipper motor.
M6, M7, M8	Coffee Dispensers current is close to critical level	Coffee Dispenser current is close to maximum operating level.	<ol style="list-style-type: none"> 1 - The dispenser may be jammed. 2 - The coffee dispenser motor may be seized. 3 - If message persists, replace the coffee dispenser motor.
	Coffee Dispensers current is close to minimum operation level	Coffee Dispenser current is close to minimum operating level.	<ol style="list-style-type: none"> 1 - Check the wiring and connections to the dispenser motor. 2 - The coffee dispenser may not be engaged with the dispenser motor. 3 - The coffee dispenser motor coupling may need to be replaced. 4 - If message persists, replace the coffee dispenser motor.
	Coffee Dispensers current is over safety level	Coffee dispenser motor current has exceeded the maximum operating level.	<ol style="list-style-type: none"> 1 - Check to see if the coffee dispenser motor is jammed. 2 - The coffee dispenser motor may be seized. 3 - Reboot the machine. 4 - If message persists, replace the coffee dispenser motor.
	Coffee Dispensers current is under minimum operation level	Coffee dispenser motor current is below the minimum operating level.	<ol style="list-style-type: none"> 1 - Check wiring and connections to the coffee dispenser motor. 2 - The coffee dispenser may not be engaged with the dispenser motor. 3 - The coffee dispenser motor coupling may need to be replaced. 4 - If message persists, replace the coffee dispenser motor.

Code	Message Displayed	Condition	Action(s) Required
M9	Brewer current is over safety level	Brewer current has exceeded the maximum operating level.	1 - The brewer may be seized/jammed. 2 - The brewer motor may need to be replaced.
	Brewer current is under minimum operation level	Brewer current is below the minimum operating level.	1 - Check the wiring and connections to the brewer motor. 2 - The brewer motor may need to be replaced.
	Brewer Inversion	Brewer is going in the wrong direction. <i>or</i> Wiper is going in the wrong direction (detected by the activation of the wrong switch).	1 - Check the wiring and connections to the brewer motor. 2 - Check wiring and connections to the wiper motor switches. 3 - One, or both, of the wiper motor switches needs to be replaced.
	Brewer Not Counting	The brewer quadrature encoder is not returning any count.	1 - Clear the message. 2 - Reboot the machine. 3 - Check the brewer motor harness connection 4 - If message persists, replace the brewer motor.
	Brewer Not Initialized	A brewer sequence was started while the brewer was not initialized.	1 - Reboot the machine to initialize the brewer. 2 - Ensure the brewer engine is properly installed and locked onto the motor base.
	Brewer Over Current Standby	The brewer current was over the configured stand by operation level.	1 - Clear the message. 2 - Reboot the machine.
	Brewer Safety Fault	The IC of the brewer driver is in fault.	1 - Clear the message. 2 - Reboot the machine. 3 - If message persists, replace the brewer motor.
	Brewer Timeout	Brewer motion is timed out: brewer is moving too slow, and unable to reach required position in the allotted period of time.	1 - Ensure the brewer engine is properly installed and locked onto the motor base. 2 - Check the brewer engine retaining ring. If the coupling at the bottom of the brewer engine can be turned by hand, the retaining ring is damaged. Repair or replace brewer engine. 3 - Check wiring and connections to the brewer motor. 4 - Brewer engine may be jammed – repair or replace brewer engine. 5 - The brewer motor may need to be replaced.
	Brewer Unexpected Item Received	A brewer sequence step was received while a wiper sequence was already in progress.	1 - Clear the message. 2 - Reboot the machine. 3 - If message persists, replace the brewer motor.

Code	Message Displayed	Condition	Action(s) Required
M10	Wiper current is over safety level	The wiper motor current was over the configured maximum operation level.	1 - The wiper may be jammed or binding. 2 - The wiper motor may need to be replaced.
	Wiper current is under minimum operation level	The wiper motor current was under the configured minimum operation level.	1 - The wiper may be missing or improperly installed. 2 - Check wiper motor connections. 3 - The motor may need to be replaced
	Wiper Inversion	The wiper limit switches are inverted.	1 - Reverse the wiring connections to the wiper switches.
	Wiper Not Initialized	A wiper sequence was started while the wiper was not initialized (homed).	1 - Clear the message. 2 - Reboot the machine. 3 - If message persists, check wiper motor switches and connections. 4 - If message persists, a wiper motor switch needs to be replaced.
	Wiper Over Current Standby	The wiper current was over the configured stand by operation level.	1 - Clear the message. 2 - Reboot the machine.
	Wiper Safety Fault	The IC of the wiper driver is in fault mode.	1 - Reboot the machine. 2 - If message persists, the control board may need to be replaced.
	Wiper Timeout	Wiper motion is timed out: wiper is moving too slow (or stopped), unable to reach required position in the allotted period of time.	1 - The wiper may be jammed/binding. 2 - Check wiper motor connections. 3 - Wiper motor may need to be replaced.
	Wiper Unexpected Item Received	A wiper sequence step was received while a wiper was already in progress.	1 - Clear the message. 2 - Reboot the machine.
S1, S2	CUP LIGHT LED #1 is not detected/ CUP LIGHT LED #2 is not detected	Cup Light LED #1 or #2 is not connected.	1- Connect the LEDs 2- Replace LED/Harness.
	Machine No Cup Light 1 Short / Machine No Cup Light 2 Short	Cup Light LED #1 or #2 is shorted.	1 - Replace LED/harness.
T1	Impossible temperature (greater than over heat or below 0)	Invalid temperature being reported.	1 - Inaccurate temperature reading - replace the temperature probe.
	Water Tank Temperature Probe Short	Temperature probe is shorted	1 - Check the wiring and connection to the temperature probe. 2 - Replace the temperature probe.
	Water Tank Temperature Probe Not Present	Temp probe is open.	1 - Check the wiring and connection to the temperature probe. 2 - Replace the temperature probe.
	Water temperature is not rising	Water temperature is not increasing while in heating mode.	1 - Check wiring and connections to heater relay, heater element and control board. 2 - If water is heating, replace the temperature probe. 3 - Check continuity of thermal cut-off on relay kit. If cut-off is open, heater relay kit needs to be replaced. 4 - Check resistance of the heater element (7.8Ω to 9.3Ω) and replace element if required. 5 - Control board may need to be replaced.

Code	Message Displayed	Condition	Action(s) Required
V1-V6	Valves & Relay current is under minimum operation level	Valves & Relay current is below the minimum operating level.	1 - Clear the message. 2 - Check wiring and connections to inlet and outlet valves. 3 - If message persists, the inlet valve or one of the outlet valves may need to be replaced.
	Valves & Relay current is over safety level.	Valves & Relay current has exceeded the maximum operating level.	1 - Clear the message. 2 - If message persists, the inlet valve or one of the outlet valves may need to be replaced.
Z99	Coffee Dispensers Over Current Standby	The coffee dispensers current sum was over the configured stand by operation level.	1 - Clear the message. 2 - Reboot the machine.
	Machine Fan Blower Over Current Standby	The fan or blower current sum was over the configured stand by operation level	1 - Clear the message. 2 - Reboot the machine.
	Powder Dispensers Over Current StandBy	The powder dispensers current sum was over the configured stand by operation level.	1 - Clear the message. 2 - Reboot the machine.
	Powder Whippers Over Current StandBy	Powder whippers current sum was over the configured stand by operation level	1 - Clear the message. 2 - Reboot the machine.
	Water Tank Coil Valves Over Current StandBy	Valve(s) current has exceeded the configured stand by operation level.	1 - Clears automatically. If not, reboot the machine.
	Water Tank Detectors Power Failure	Fault signal triggered due to a failure of the level probes and overflow detector power supply.	1 - Clear the message. 2 - Reboot the machine. 3 - If message persists, replace the control board.
	Water Tank Heater Over Current StandBy	Heater current has exceeded the configured stand by operation level.	1 - Clears automatically. If not, reboot the machine.

SECTION 6

Updating Firmware



Never attempt to install an older version of software than the version currently installed in your equipment as it is not backwards compatible! This may result in a failure of the HMI (touch screen) and void its warranty.

Firmware updates may be released periodically for the Eccellenza Momentum™. These updates may consist of fixes, new options and features, customizations, etc. This section guides you through the simple process of updating your equipment to the latest firmware.



After replacing the control board, the firmware must be loaded when the machine is first powered up. Do not power up the machine until the USB Flash drive with the proper firmware is connected to the machine.

1. Load the latest firmware files onto an **empty** USB flash drive (minimum **8GB**).
2. Open the front door.
3. Remove the plug from the USB connector and insert your USB flash drive into it. ***Make sure to push the USB flash drive into the USB connector as far as it can go.***

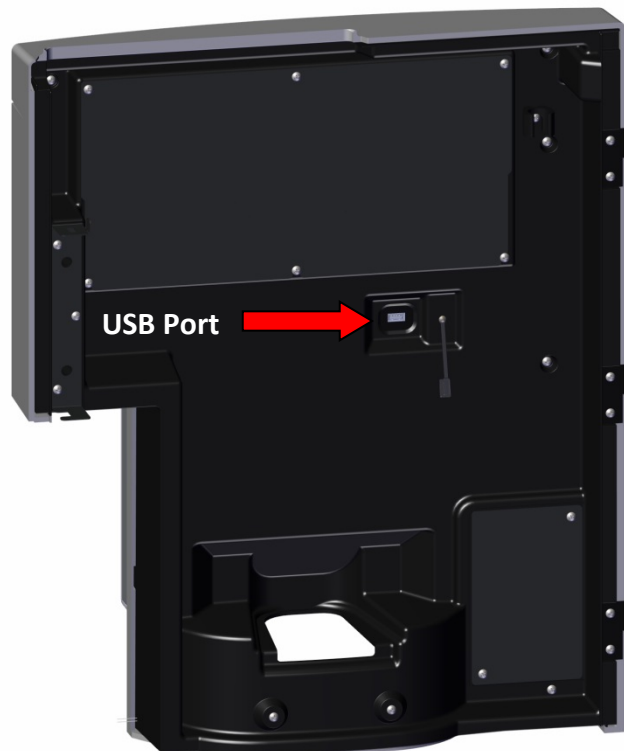

4. Reboot the machine using the main power switch (switch the power off for 5 seconds and then on again).
5. If the existing software in the machine is 2.7.0 or higher, the upgrade begins automatically. If the existing software in the machine is **lower than 2.7.0**, you will be asked if you want to do a Fresh Install (which erases the counters and resets all settings), or if you want to exit without upgrading so that you can **manually** upgrade the machine to 2.7.0 first, and then to 3.1.0.
6. The updating process is automated and requires no user input. The screen reverts to command-style prompts that provide progress information on the update.

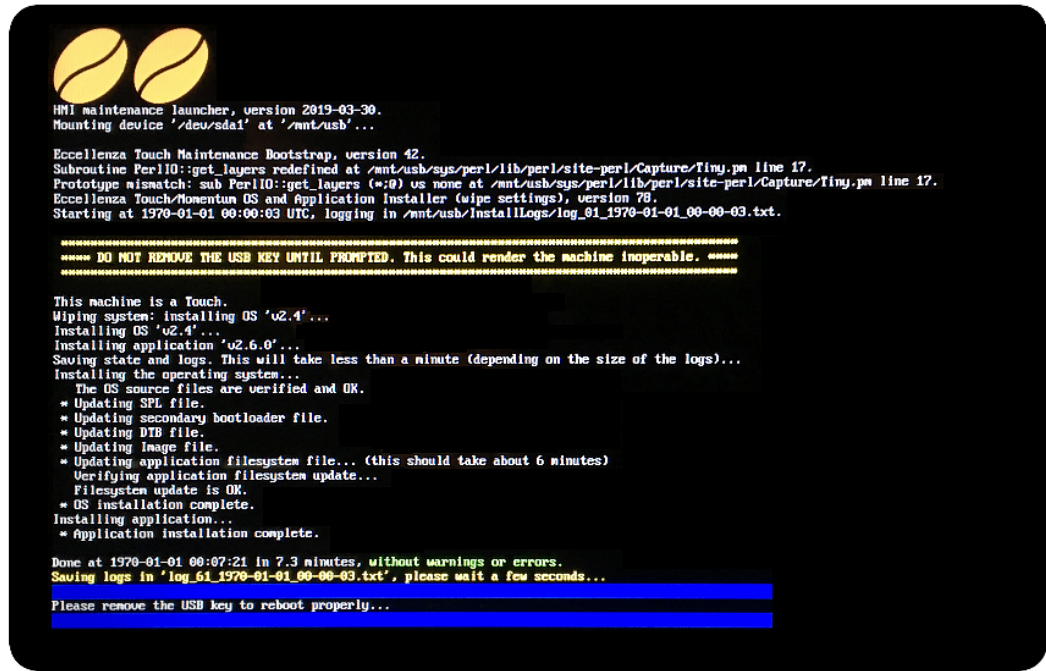

7. Once the update is complete (it may take up to 30 minutes), you are prompted to remove the USB flash drive to reboot the machine.

Remove the flash drive and the Eccellenza Momentum™ will reboot itself twice. While it is rebooting, re-install the plug onto the USB connector and re-install the waste bin.



If the screen remains black with a “log-in” prompt, allow the machine sit undisturbed for 15 minutes or so as the upgrade may still be in progress in the background.

8. It is possible that an error may be displayed on the screen after the reboot. If this is the case, simply clear the error.



If the update process was interrupted prior to completion, you must connect the USB flash drive to a computer, and delete the “Backup” folder that was created, otherwise further updates will not be possible with this flash drive.



Updating the Eccellenza Momentum™ firmware will not overwrite or change any existing settings or customizations you may have made in the programming. These settings will be maintained.

SECTION 7

Installing the Card Reader Option

The Eccellenza Momentum™ is compatible with the most popular card reader options available – the Coinco® Iris, Nayax® VPOS or USA Technologies® G9 card readers.

Please note that VKI Technologies does not provide the card reader hardware, or the service – they must be purchased from one of the suppliers listed above.

Depending on the type of card reader to be used, you'll need to purchase the compatible door cover from VKI Technologies. See step #5 for more details.

1. With the front door open, remove the two screws securing the small panel to the inside of the door, and then remove the panel and set it aside.



2. Remove the screw at the top center of the opening, and then remove the original full cover from the outside of the door.

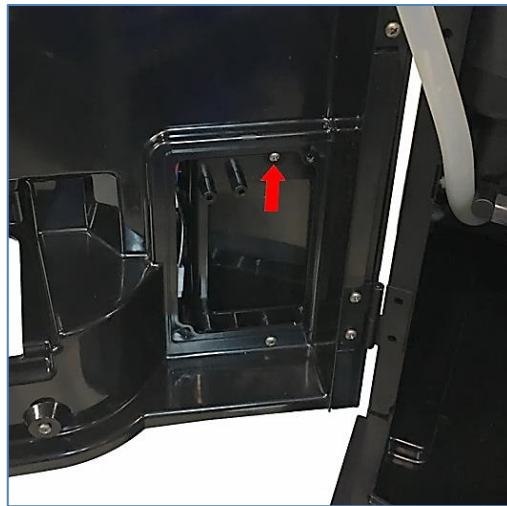

3. **Partially** insert the two lower screws at the card reader opening on the front of the door. **Do not tighten these screws at this point.**

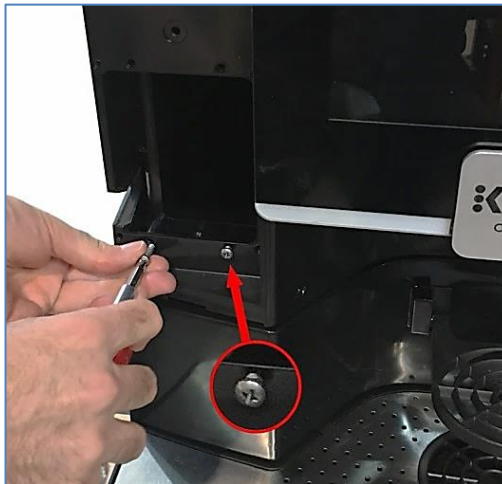

4. Pass the card reader wiring to the rear of the door (through the card reader opening), and then slide the bottom of the card reader onto the two partially inserted screws. Once done, secure the top of the card reader with two screws, and then tighten the two lower screws to secure the bottom of the card reader.



5. Install the appropriate cover (for card reader being used) onto the front of the door, and secure it in place with a screw from the inside of the door (at top center of card reader opening).



6. Remove the inner access panel at the top of the door (4 screws). This exposes several wire-tie anchor points, onto which the card reader control module will be installed.

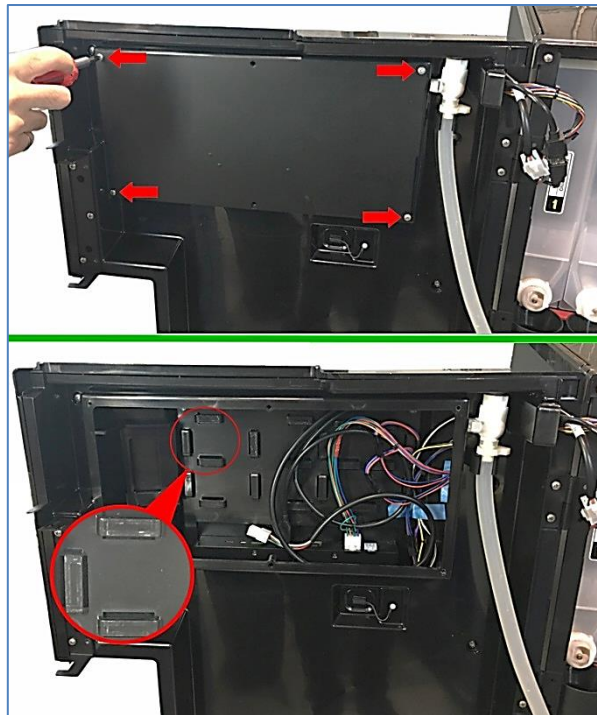

7. Secure the card reader module using wire-ties to **at least two** of the anchor point in the door. The installation location may vary depending on the model of card reader used.

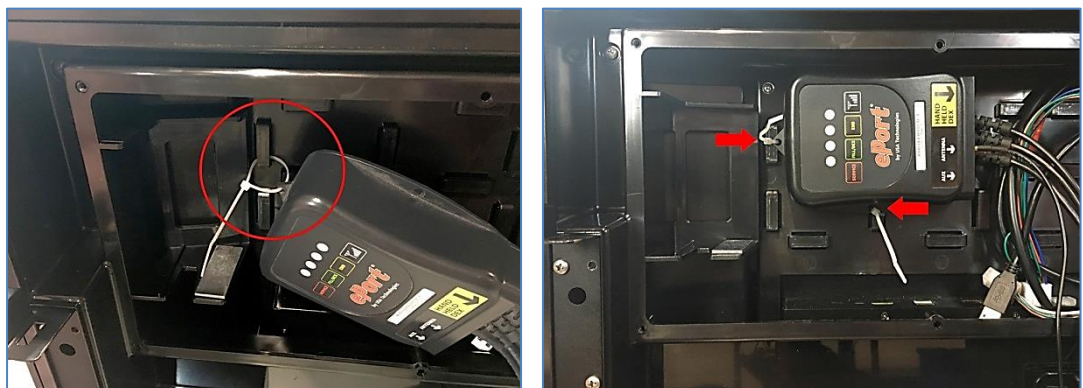

- Connect the 6-pin male MDB connector from the card reader, to the 6-pin female MDB connector on the door wiring, and then install the magnetic antenna onto the metal plate to the left of the control module.

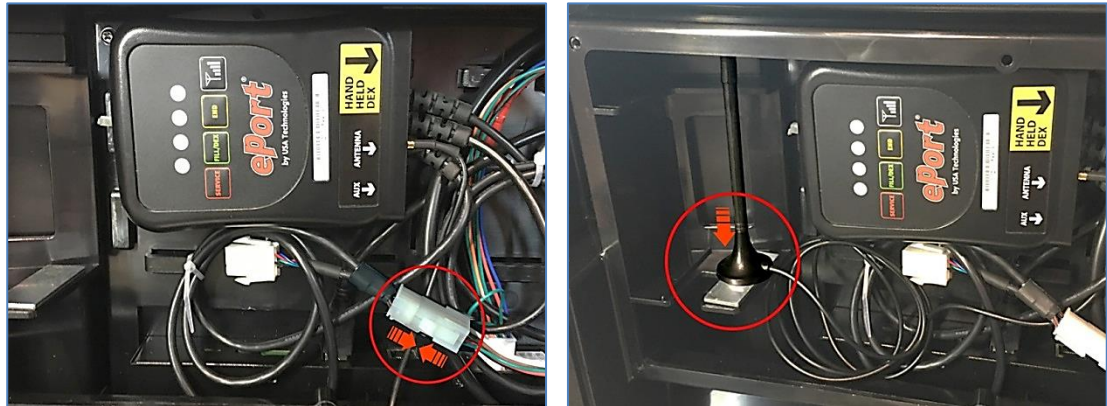

- Before proceeding, ensure that the USB cable and the door wiring harness are still connected to the locations shown.

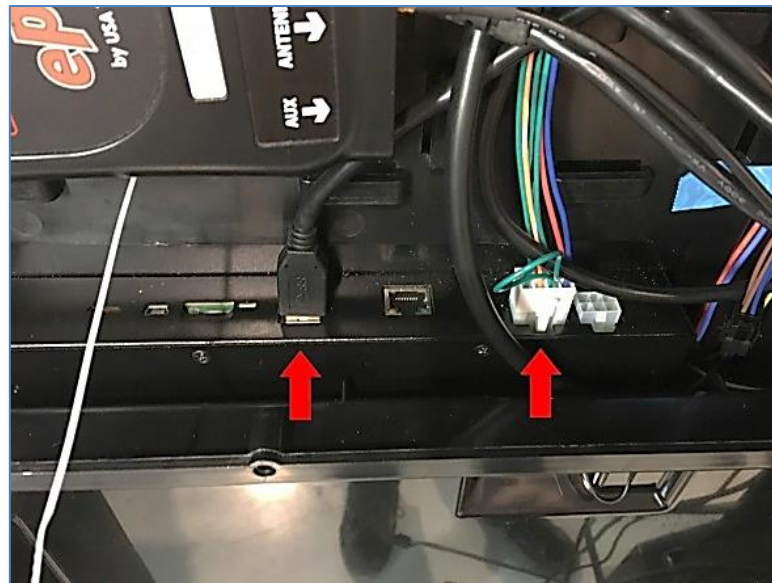

- Pass the wiring cable with the small black connector through the channel at the top of the door, to the bottom of the door where the card reader is located, and then connect it to the cable on the card reader.

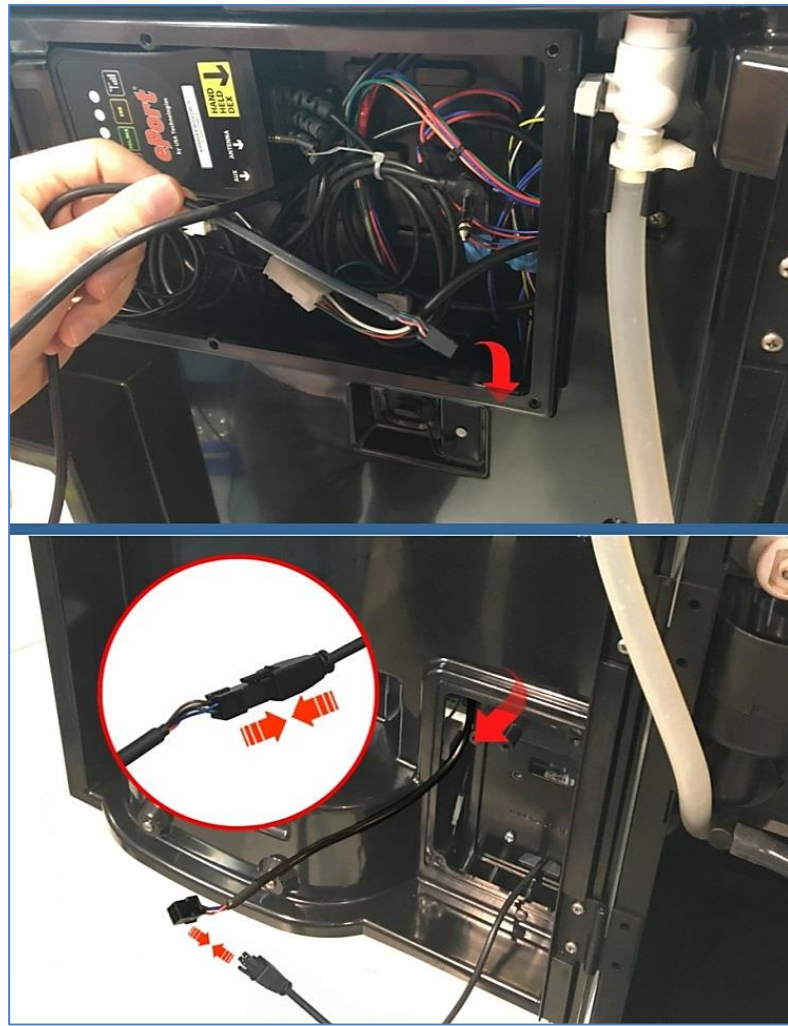

11. Bundle and stow any excess wiring inside the opening for the card reader (at the bottom of the door) and reinstall the cover using two screws.

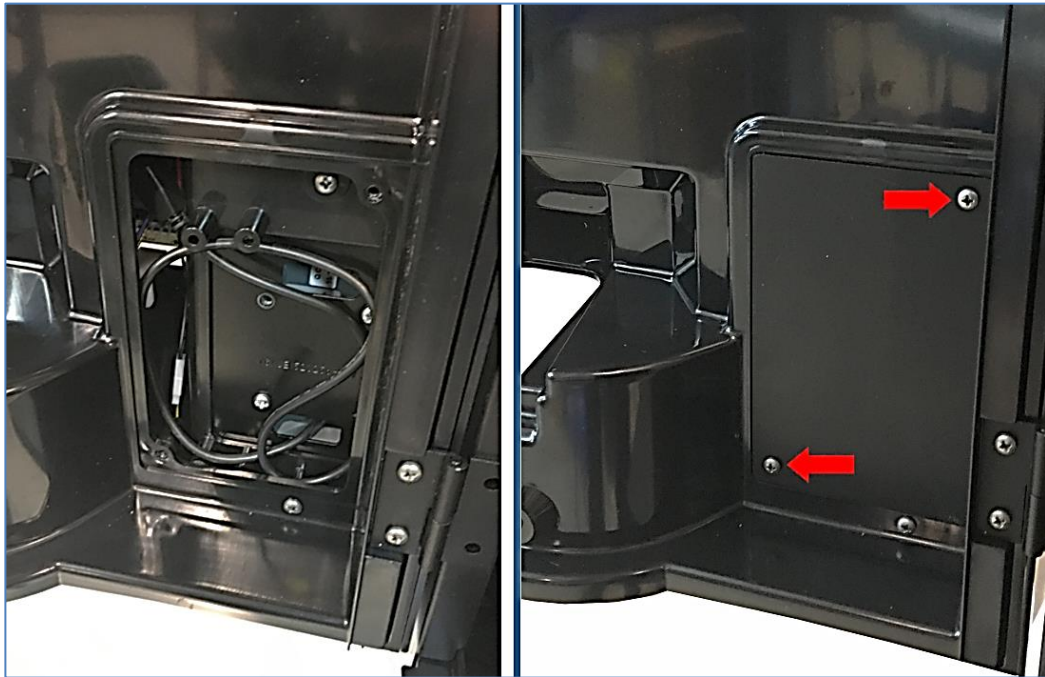

12. Bundle and stow any excess wiring inside the opening at the top of the door, and reinstall the cover using four screws .

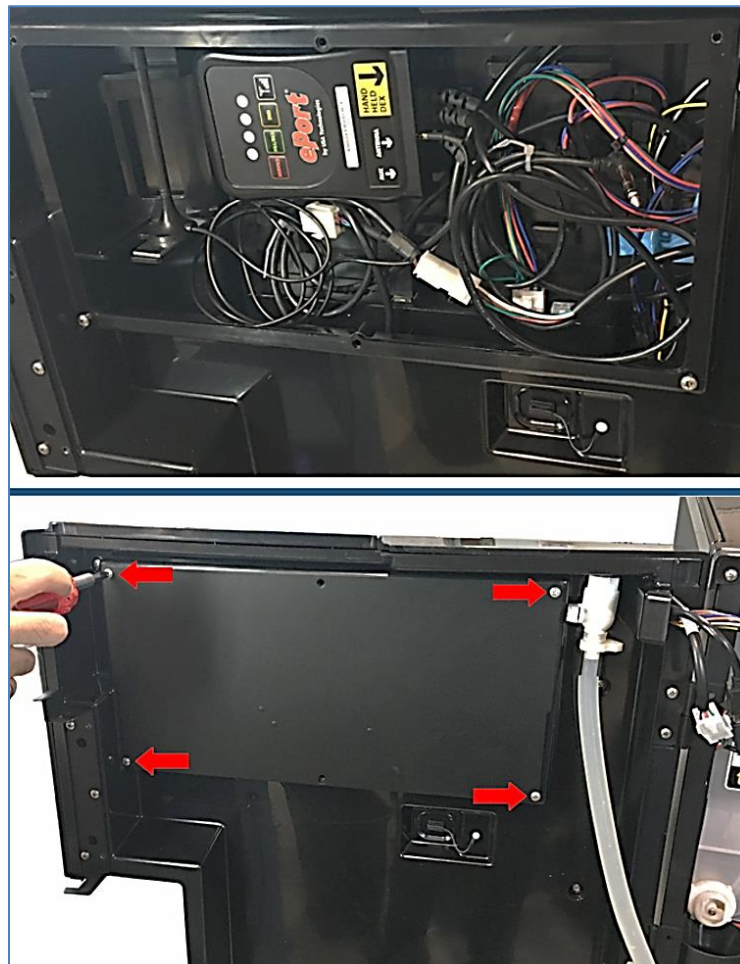

13. Enable the “**Card Reader**” option in the Momentum™ programming.
 - a) Enter the “**Programming**” Mode (see page 23).
 - b) Select the “**Vending**” Menu (see page 47).
 - c) In the “**General**” tab, enable ‘**Vending Mode**’ and enable ‘**Cashless**’ (the sliders for both must be **green**).

The card reader will now be functional, assuming you have subscribed to, and activated the service with the card reader provider.

Please note that Keurig does not offer the card reader hardware, nor do we provide the card reader service. You will need to contact one of the approved card reader suppliers (Coinco, Nayax, USA Technologies, SEM) for more details.

SECTION 8

Product Warranty Information

Important note: The serial number of the machine must be reported at the time a warranty claim is submitted on a machine or any of the components contained therein. Any removal of or tampering with the serial number or date code of a component will void warranty.

Limited One-Year Warranty

Keurig Green Mountain, Inc. warrants to the original purchaser that its coffee maker will be free of defects in materials or workmanship under normal use for one-year from the date of purchase. Keurig, a Keurig Authorized Distributor or Service Agent will, at their option, repair or replace a defective coffee maker or coffee maker parts under this warranty without charge upon its receipt of proof of the date of purchase. If a replacement coffee maker is necessary to service this warranty, the replacement coffee maker may be new or reconditioned. If a replacement coffee maker or parts are sent, a new limited one-year warranty will be applied to the replacement coffee maker or parts. This warranty only applies to coffee makers operated in the United States and Canada. This warranty gives the original purchaser specific legal rights, and you may also have other rights that vary from state to state and, in the case of Canada, from province to province. If you obtained this coffee maker through sale or rental from a Keurig Authorized Distributor, you may also want to refer to your distributor's warranty policies. Only the use of Keurig® accessories will guarantee the proper functioning and lifetime of Keurig® coffee maker. Any damage to or malfunction of your coffee maker resulting from the use of non Keurig® accessories may not be covered by this warranty or may result in a service fee if the damage or malfunction is determined to be caused by such use.

What is not covered by the Limited Warranty?

THIS WARRANTY DOES NOT COVER CONSEQUENTIAL OR INCIDENTAL DAMAGES SUCH AS PROPERTY DAMAGE AND DOES NOT COVER INCIDENTAL COSTS AND EXPENSES RESULTING FROM ANY BREACH OF THIS WARRANTY, EVEN IF FORESEEABLE. Some states or provinces do not allow the exclusion or limitations of incidental or consequential damages, so the above limitation or exclusion may not apply to you depending on the state or province of purchase. Nor does this warranty cover damages caused by use of non Keurig® accessories, services performed by anyone other than Keurig or its authorized service providers, use of parts other than genuine Keurig parts, or external causes such as abuse, misuse, inappropriate power supply, or acts of God.

Other Limitations

THIS WARRANTY IS EXCLUSIVE AND IS IN LIEU OF ANY OTHER EXPRESS WARRANTY, WHETHER WRITTEN OR ORAL. IN ADDITION, KEURIG HEREBY SPECIFICALLY DISCLAIMS ALL OTHER WARRANTIES WITH RESPECT TO YOUR ECCELLENZA MOMENTUM™ COFFEE MAKER, INCLUDING ANY IMPLIED WARRANTY OF MERCHANTABILITY OR FITNESS FOR ANY PARTICULAR PURPOSE. Some states or provinces do not allow disclaimers of such implied warranties or limitations on how long an implied warranty lasts, so the above limitation may not apply to you depending on the state or the province of purchase.

How do you obtain warranty service?

Keurig® coffee makers are high-quality appliances and, with proper care, are intended to provide years of satisfying performance. However, should the need arise for warranty servicing; simply call your Keurig Authorized Distributor (KAD) who originally sold you the coffee maker or your Keurig Authorized Service Provider (KASP) for full support. To be re-connected with your KAD or KASP, please call Keurig at 1.888.287.2739 ex.5. If in Canada, please call: 1.888.382.1145.